

CHILLED Flow

Fan Coil Units



Dunnair Quality Engineering Solutions

Dunnair is now firmly positioned as a leading supplier to the air conditioning industry.

The name Dunnair is synonymous with high quality products in the commercial air-conditioning industry. Beginning with Dunn Air Conditioning in 1961 and more recently, Dunnair International and Dunnair Australia, the company continues to be a leading importer and supplier of air-conditioning brands for the Australian market.

In 1994, the company was bought by Multistack and renamed Dunnair International. In 2004, Ernest Ugazio acquired the sales and subsequently state service department of Dunnair. This led to the company being divided into separate entities: Dunnair International and Dunnair Australia, the former focused on Multistack Chiller sales and spare parts; while the latter began design and development of a split ducted and rooftop packaged range that was manufactured in China.

The **CHILLEDFLOW Fan Coil Units** shown in this brochure are part of Dunnair's range of high quality units for every application. Dunnair has also become the first choice when individual engineering solutions are required. Fast-moving and responsive, Dunnair supplies made-to-measure HVAC solutions to a growing number of high profile developments across Australia.

Dunnair research and development plus a strict quality control program have been fundamental to our growth, success and reputation. Dunnair units are manufactured in accordance with strict quality control standards and are MEPS rated and developed for Australian conditions.

Range: Dunnair's two modern factories manufacture 16 separate product lines and some 600 different models. Dunnair can supply most products the HVAC industry requires. This new product line of **CHILLEDFLOW Fan Coil Units** is proof of that the company is working continuously to improve its product range and the efficiency of its products.

Specialised Solutions: Dunnair will engineer and manufacture equipment to suit the application and building design. No challenge will go unaccepted. We will design and make special products as required for the building, mining, transport and maritime industry. We employ mechanical engineers in all sales offices in Australia. Their role is dedicated to supporting designers to achieve their goals.

Our promise to the system designers is: **"Tell us what you need and we will work with you to deliver"**.

With a head office in Melbourne, Dunnair has offices in New South Wales, Queensland, South Australia, Western Australia and Tasmania. Dunnair maintains a dedicated engineering and sales support staff waiting to assist you with technical and product information and provide valuable solutions for your project.

Dunnair will design, build and deliver HVAC equipment to meet the most stringent specifications and difficult applications.



Fan Section

High quality centrifugal fans are used. The professional software is used for fan selection to better reach the duty point of high efficiency and low noise level. All fans are statically and dynamically balanced.

1. Wheels

All standard DUNNAIR fan coil units use sirocco fan wheels selected and are approved by DUNNAIR engineers. Wheel parts are made of aluminium alloy or galvanized steel, rust prevention treated. All fan wheels are dynamically balanced at the fan wheel manufacturer's workshop. When fans are being mounted in their sections, the entire fan assemblies are again balanced and trimmed at the AHU factory.



2. Casing

Casings are made of galvanized steel, designed and manufactured to be aerodynamic, resulting in high efficiency and low noise.

Motor Section

- Low noise single-phase capacity motor
- Optimization designed, high efficiency, energy saving
- Low noise rolling bearing, oiling free, durable for over 12 years
- Carbon steel shaft, coated with nickel, rust prevention
- Motor as standard & five speed motor as option.



Coil Section

Dunnair owns two heat exchanger manufacturing lines from OAK Company (USA).

All Dunnair's coils are constructed with 0.15mm thick rippled corrugated fins in selective 8,10 or 12 fins per-inch spacing and 5/8 inch nominal diameter copper tubes 0.50mm thick, mechanically bonded together by a tube expander. This advanced engineering provides continuous turbulence between fins, thus eliminating a layer of air that reduce fin-to-air heat exchange.

All Dunnair's coils are tested for leaks at the AHU factory with 25 kgfcm² (350 psig) pressure air, filled and submerged in a water pool. Standard Coil is warranted for use with not more than 18 kg/cm² (250 psig) working pressure. Coils that can withstand a higher pressure rating are available.

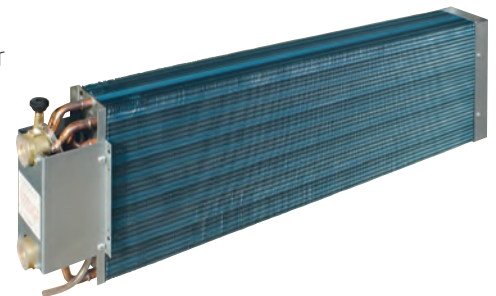

Drain Pan

To assure there is no leakage, the fabrication of drain pan is by a one-piece stamping process, seamless with no joints. U-shape drain pan is made of 1 mm thick galvanized steel coated with anti- corrosion material.

Drain pan has one outside pipe thread connection and drain connection. Location is in the middle of the U-shape to discharge water efficiently without overflow.

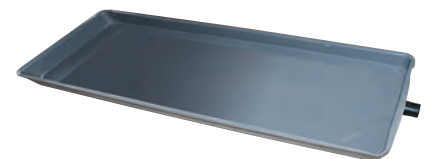

Filter Section (option)

According to units model and size of return air inlet, customize the size of filter; High efficiency, installation flexibility; Filter is made of chinlon fibre.

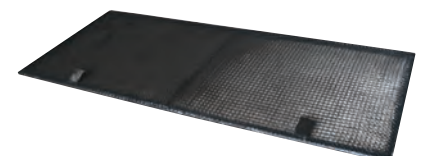

CHILLED FLOW Fan Coil Units

A wide product range

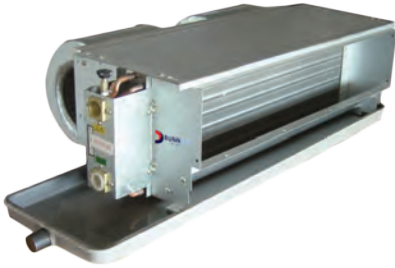

Large Capacity Fan Coil Units - DF

- 12 models – from 3.0 to 30.0 kW
- 4 pipe



Ceiling Concealed type - AW

- 10 models – from 2.0 to 12.5 kW
- 2 pipe /4 pipe
- EC motor available as option



Floor Concealed type - AL

- 10 models – from 2.0 to 13.0 kW
- 2 pipe

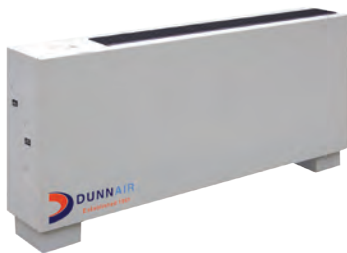

Floor Exposed type - ML

- 10 models – from 2.0 to 12.5 kW
- 2 pipe



Ceiling Exposed type - CE

- 9 models – from 2.0 to 13.0 kW
- 2 pipe



Ceiling Cassette - XD

- 9 models – from 1.8 to 10.8 kW
- 2 pipe

Large Capacity Fan Coil Units

General Specification

- Five speed for each model, air flow 86–1600 l/s
- Cooling capacity 3.0–30.0 kW
- Heating capacity 4.0–40.0 kW
- Copper tube, aluminium fin, interlaced tube arrangement, high heat transfer efficiency
- 9.52 diameter copper tube
- Large capacity fan coil units with five speed motor, adjustable airflow, cooling and heating capacity
- KDF Series centrifugal fan, large capacity, low noise, high efficiency.
- Power supply 240V/50HZ/1Ph

Nomenclature

FCU	-	30	DF	-	Z	W	D	G
[1]		[2]	[3]		[4]	[5]	[6]	[7]

[1] **FCU:** Fan Coil units

[2] **Airflow code:** 30, 45, 60, 80, 100, 130, 160, 180, 200, 240, 300, 350
Nominal airflow: Air flow code *4.7 l/s

[3] **Model DF:** large capacity discharge type

[4] **Handing: Z:** left hand

Y: right hand (facing air outlet)

[5] **W: With return plenum, N/A:** without plenum

[6] **D: Electric heater, N/A:** without heater

[7] **G: Filter, N/A:** without filter

Large Capacity Fan Coil Units

1. Condensate water outlet 3/4MPT
2. Water inlet 3/4FPT
3. Water outlet 3/4FPT
4. Junction box

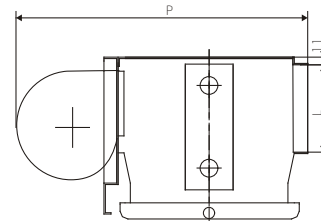
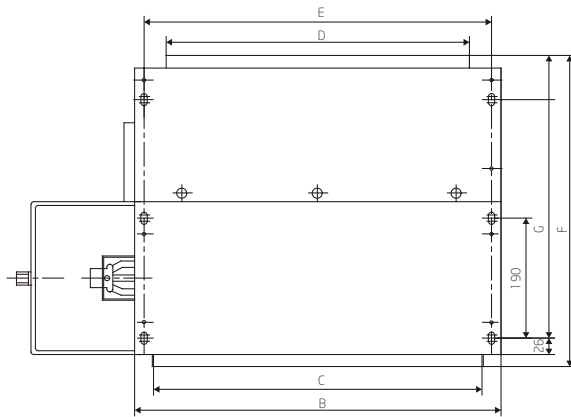
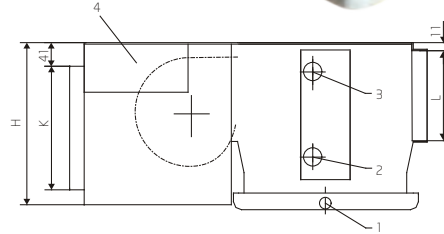
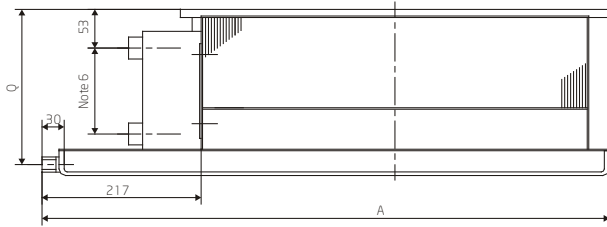
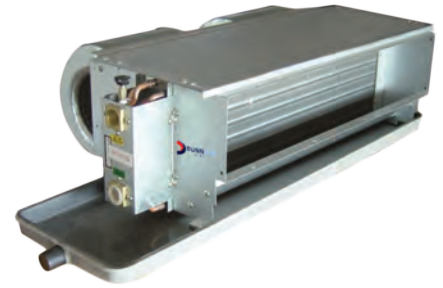

Dimension

Model		DF30	DF45	DF60	DF80	DF100	DF130	DF160	DF180	DF200	DF240	DF300	DF350
Code													
A	Extended	1016	1251	1486	1286	1511	1691	1926	2111	2291	2361	2441	2711
	Standard	816	1051	1286	1086	1311	1491	1726	1911	2091	2161	2241	2511
	B	625	860	1095	895	1120	1300	1535	1720	1900	1970	2050	2320
	C	565	800	1035	835	1060	1240	1475	1660	1840	1910	1990	2260
	D	525	760	995	795	1020	1200	1435	1620	1800	1870	1950	2220
	E	555	830	1025	865	1090	1270	1505	1690	1870	1940	2020	2290
	F	556	556	556	596	596	596	596	596	596	636	636	636
	G	431	431	431	471	471	471	471	471	471	511	511	511
	H	288	288	288	338	338	338	338	338	338	381	381	381
	K	228	228	228	278	278	278	278	278	278	321	321	321
	L	175	175	175	225	225	225	225	225	225	225	225	225
	P	513	513	513	560	560	560	560	560	560	597	597	597
	Q	279	279	279	329	329	329	329	329	329	329	329	329
	M	1	1	1	1	1	1	1	2	2	2	2	2
	N	1	1	2	1	2	2	2	3	4	4	4	4

Note:

1. M - Number of motors
2. N - Number of fans
3. Two types of drain pan: extended, standard
4. Return air inlet with filter (option)
5. Bottom return plenum
6. Model DF30 ~ DF60 : 118mm
Model DF80 ~ DF200 : 219mm

Performance Data and Correction Factor

Performance data

	Mode		30	45	60	80	100	130	160	180	200	240	300	350
	ESP													
Airflow (l/s)	SH	120Pa	143	211	281	375	468	609	749	843	936	1124	1405	1639
	HH	100Pa	130	191	256	341	425	555	682	767	852	1023	1278	1492
	H	80Pa	119	175	233	311	388	505	621	699	778	934	1164	1361
	M	60Pa	107	158	211	281	351	457	562	632	702	843	1053	1228
	L	40Pa	86	127	169	225	281	365	449	506	562	674	843	983
Cooling capacity (kW)	SH	120Pa	3.0	4.0	5.7	7.2	9.2	11.7	15.0	18.0	20.0	21.7	27.0	29.7
Heating capacity (kW)	SH	120Pa	4.4	6.0	8.6	10.8	13.8	17.6	22.5	27.0	30.0	35.0	43.3	48.2
Water flow (l/min)	SH	120Pa	9	14.2	20	25.7	30	39.5	49.2	65.5	73.6	77.8	94.2	104.8
Water resistance (kPa)	SH	120Pa	8.81	21.06	47.41	76.8	28.56	51.77	66.26	65.99	78.68	82.26	86.28	89.24
Input power (W)	SH	120Pa	130	177	230	354	357	525	637	707	721	950	1100	1290
Noise (dBA)	SH	120Pa	52	53	54	54	56	57	58	59	60	61	62	63
Rows of heat exchanger			3	3	3	3	3	3	3	4	4	4	4	4
Weight (kg)			26	35	42	44	46	53	61	74	81	87	95	97

Note:

- Nominal condition is based on Australian standard/T19232-2003.
Cooling: Return air temp. DB 27°C, WB 19.5°C
Chilled water inlet temp. 7°C, water temp rise 5°C
Heating: Return air temp. DB 21°C, hot water inlet temp 60°C
Water flow rating is same as cooling
- Standard working pressure of fan coil units is 1.8 Mpa, if the requirement is over 1.8 Mpa, please indicate when ordering.

Correction factor of cooling and heating capacity

Mode	30	45	60	80	100	130	160	180	200	240	300	350
ESP												
120Pa	1	1	1	1	1	1	1	1	1	1	1	1
100Pa	0.92	0.92	0.93	0.92	0.91	0.92	0.91	0.92	0.92	0.91	0.92	0.92
80Pa	0.85	0.86	0.86	0.86	0.85	0.85	0.85	0.86	0.86	0.85	0.86	0.86
60Pa	0.78	0.8	0.8	0.79	0.79	0.79	0.78	0.8	0.79	0.78	0.79	0.8
40Pa	0.68	0.71	0.7	0.69	0.68	0.68	0.68	0.7	0.69	0.68	0.69	0.69

Cooling Performance data

Air on temperatures DB 24°C, WB 17.8°C

Model	Water Flow Rate l/min	Water pressure drop Kpa	Design condition: Return air DB 24°C Return air WB 17.8°C									
			Chilled water inlet temperature °C									
			5		6		7		8		9	
			SH (W)	TH (W)	SH (W)	TH (W)	SH (W)	TH (W)	SH (W)	TH (W)	SH (W)	TH (W)
30	9	8.81	2317	2909	2114	2649	1960	2454	1398	1751	1255	1582
	15	12.86	2607	3617	2337	3226	2032	2796	1758	2412	1455	2001
	20	14.21	2706	3890	2481	3523	2179	3062	1953	2718	1643	2276
	30	16.55	3016	4393	2799	4016	2511	3553	2282	3188	1996	2768
45	9	12.34	2427	3054	2252	2827	2109	2646	1474	1850	1310	1654
	15	22.78	3199	4461	2839	3939	2438	3370	2079	2866	1681	2324
	20	24.6	3248	4726	2929	4211	2551	3628	2217	3122	1853	2599
	30	26.8	3548	5246	3247	4729	2809	4035	2545	3610	2195	3091
60	15	44.96	4216	5314	3912	4907	3542	4426	2836	3535	2228	2784
	20	48.38	4516	6329	3994	5569	3533	4909	2885	3998	2312	3212
	30	49.82	4779	7037	4592	6682	3757	5408	3320	4733	2826	4011
	40	51.34	5171	7762	4967	7344	4216	6148	3660	5270	3207	4584
80	15	72.68	5272	6679	4737	5960	4569	5716	3363	4188	2882	3591
	20	75.32	5420	7634	4761	6673	4278	5974	3547	4939	2993	4180
	30	77.68	5523	8231	4877	7183	4283	6240	3710	5352	3062	4398
	40	78.21	5810	8854	5220	7836	4636	6864	4045	5914	3426	4971
100	15	22.76	6084	7762	5514	7021	5146	6548	4230	5386	3303	4229
	20	25.98	6749	9554	5949	8380	5211	7313	4414	6178	3427	4810
	30	29.64	6870	10364	6066	9042	5276	7779	4497	6567	3580	5205
	40	32.89	7746	11985	6328	9645	5591	8403	4875	7236	3900	5746
130	20	46.98	7006	8957	6861	8745	6048	7696	5241	6666	4800	6133
	30	49.68	7255	10321	6897	9764	6253	8819	5343	7517	4863	6860
	40	53.77	7933	12113	7353	11037	6927	10234	5731	8343	5182	7473
	50	60.32	8254	12966	7496	11716	6946	10816	6222	9664	5286	8231
160	30	58.96	8575	10995	7881	10035	6999	8861	6226	7847	5599	7061
	40	61.12	8859	12667	7915	11249	7569	10708	6387	9003	5715	8070
	49	68.11	9006	13989	8824	13542	8659	13146	6570	9879	5875	8796
	60	73.21	9078	14330	8845	13754	8675	13304	6649	10069	5965	8966
180	40	59.86	11269	14552	10040	12939	9536	12280	8193	10556	6651	8619
	50	62.31	11415	16420	10639	15197	10134	14394	8530	12060	7586	10733
	65	69.69	11665	18340	10937	16988	10233	15725	9063	13794	8143	12339
	75	74.41	12015	19256	11514	18177	10473	16307	9510	14622	8487	12952
200	50	65.3	12987	16804	12031	15537	11116	14344	9258	11952	7763	10079
	60	79.61	13357	19350	12417	17898	11964	17181	9281	13294	7987	11472
	74	83.23	13616	21666	12572	20206	11006	17888	9436	15529	8335	13961
	85	89.4	13667	22238	12753	20440	11580	18304	10378	16198	9462	14659
240	60	73.3	13539	18612	12464	17477	11300	16182	9634	14107	8044	12107
	70	84.4	14009	20396	13450	19544	12612	18312	10121	14703	8816	12880
	78	92.5	14348	22605	13581	21140	12805	19718	10290	15694	8981	13638
	90	96.4	14681	23202	13943	21925	12852	20134	10646	16636	9438	14788
300	70	85.5	14152	19073	13508	18169	12950	17405	10111	13596	9112	12323
	85	93.4	14325	20899	14037	20376	13520	19552	11166	16107	9530	13784
	95	99.6	17331	27637	15735	24791	14413	22464	11718	18089	10816	16624
	105	116.8	17991	28576	17365	27168	15529	23962	13174	20072	12326	18642
350	70	89.31	18191	24566	16252	21904	14412	19411	10912	14703	9582	12985
	85	94.22	18611	27287	17686	25801	16944	24627	11350	16454	9665	14050
	95	107.37	18860	29343	18447	28357	17781	27040	11571	17429	9794	14687
	105	129.24	18900	29940	18527	28908	18219	28038	14277	21695	11198	16891

Note:

1. The data in table is acquired under 120 Pa ESP condition
2. When ESP is changed, the air flow will change in accordance. Therefore heat capacity will need to be calculated by multiplying correction factors
3. Interpolation method could be applied when no exact value can be found on above table
4. When inlet temperature beyond the range, please consult design engineer for advice

Cooling Performance data

Air on temperatures DB 26°C, WB 19.5°C

Model	Water Flow Rate l/min	Water pressure drop Kpa	Design condition: Return air DB 26°C Return air WB 19.5°C									
			Chilled water inlet temperature °C									
			5		6		7		8		9	
			SH (W)	TH (W)	SH (W)	TH (W)	SH (W)	TH (W)	SH (W)	TH (W)	SH (W)	TH (W)
30	9	8.81	2676	3366	2454	3079	2332	2921	1671	2082	1544	1919
	15	12.86	3011	4185	2712	3751	2418	3326	2101	2867	1790	2428
	20	14.21	3126	4501	2880	4096	2592	3643	2334	3231	2021	2761
	30	16.55	3485	5083	3249	4669	2987	4227	2727	3791	2455	3358
45	9	12.34	2804	3533	2614	3287	2509	3148	1762	2200	1612	2007
	15	22.78	3696	5162	3296	4580	2900	4010	2484	3408	2068	2820
	20	24.6	3752	5468	3400	4896	3035	4316	2649	3712	2280	3152
	30	26.8	4099	6070	3769	5498	3342	4802	3041	4291	2701	3750
60	15	44.96	4870	6149	4541	5705	4214	5267	3390	4203	2740	3378
	20	48.38	5217	7324	4636	6475	4203	5841	3448	4753	2844	3896
	30	49.82	5521	8143	5331	7768	4470	6435	3968	5627	3476	4866
	40	51.34	5974	8982	5765	8538	5016	7316	4374	6265	3945	5561
80	15	72.68	6090	7728	5499	6929	5436	6801	4019	4979	3545	4357
	20	75.32	6262	8834	5527	7758	5090	7108	4239	5872	3682	5071
	30	77.68	6380	9525	5662	8350	5096	7425	4433	6363	3766	5336
	40	78.21	6712	10245	6059	9110	5515	8168	4835	7031	4214	6031
100	15	22.76	7029	8982	6400	8162	6122	7791	5056	6403	4063	5130
	20	25.98	7797	11054	6905	9742	6200	8702	5275	7345	4216	5835
	30	29.64	7937	11992	7042	10512	6276	9257	5374	7807	4404	6315
	40	32.89	8949	13867	7346	11212	6651	9999	5826	8602	4798	6970
130	20	46.98	8094	10364	7963	10166	7195	9158	6264	7925	5905	7440
	30	49.68	8381	11943	8006	11351	7439	10494	6386	8936	5982	8322
	40	53.77	9165	14015	8535	12831	8241	12177	6849	9918	6375	9066
	50	60.32	9536	15002	8701	13621	8263	12870	7436	11489	6502	9986
160	30	58.96	9906	12722	9148	11666	8326	10544	7441	9329	6888	8566
	40	61.12	10235	14657	9187	13078	9005	12741	7634	10704	7031	9790
	49	68.11	10405	16187	10242	15743	10300	15642	7852	11745	7228	10671
	60	73.21	10487	16582	10267	15989	10319	15830	7946	11971	7337	10877
180	40	59.86	13019	16838	11654	15042	11344	14612	9792	12550	8182	10456
	50	62.31	13187	19000	12349	17667	12056	17127	10194	14337	9333	13021
	65	69.69	13477	21221	12695	19750	12174	18711	10832	16399	10017	14969
	75	74.41	13881	22282	13365	21132	12459	19404	11366	17383	10441	15713
200	50	65.3	15004	19444	13966	18062	13223	17068	11064	14210	9550	12228
	60	79.61	15432	22390	14413	20807	14232	20444	11092	15805	9826	13916
	74	83.23	15730	25070	14593	23491	13093	21285	11277	18462	10254	16937
	85	89.4	15789	25731	14803	23762	13775	21780	12402	19257	11640	17784
240	60	73.3	15642	21536	14467	20318	13442	19256	11513	16771	9896	14688
	70	84.4	16184	23600	15613	22721	15003	21790	12096	17480	10845	15625
	78	92.5	16576	26156	15764	24576	15233	23463	12298	18658	11049	16545
	90	96.4	16961	26846	16184	25488	15289	23958	12723	19777	11611	17940
300	70	85.5	16350	22069	15679	21122	15405	20711	12083	16164	11209	14949
	85	93.4	16550	24182	16294	23688	16083	23265	13345	19149	11723	16721
	95	99.6	20023	31979	18265	28820	17146	26730	14005	21506	13306	20167
	105	116.8	20785	33065	20157	31584	18474	28512	15744	23863	15164	22615
350	70	89.31	21016	28426	18865	25465	17145	23097	13041	17480	11788	15752
	85	94.22	21501	31574	20529	29995	20157	29304	13564	19561	11890	17044
	95	107.37	21789	33953	21412	32966	21153	32175	13829	20720	12049	17818
	105	129.24	21836	34644	21505	33607	21674	33363	17062	25792	13776	20490

Note:

1. The data in table is acquired under 120 Pa ESP condition
2. When ESP is changed, the air flow will change in accordance. Therefore heat capacity will need to be calculated by multiplying correction factors
3. Interpolation method could be applied when no exact value can be found on above table
4. When inlet temperature beyond the range, please consult design engineer for advice

Cooling Performance data

Air on temperatures DB 27°C, WB 19.5°C

Model	Water flow (L/min)	Water resistance (kPa)	Indoor condition: Return air temp. DB 27°C, WB 19.5°C									
			Chilled water inlet temp. °C (coil)									
			5		6		7		8		9	
			SH(W)	TH(W)	SH(W)	TH(W)	SH(W)	TH(W)	SH(W)	TH(W)	SH(W)	TH(W)
30	9	8.81	2560	3410	2210	3120	2050	2950	1700	2120	1450	1960
	15	12.86	3270	4240	2950	3800	2570	3360	2370	2920	2180	2480
	20	14.21	3590	4560	3280	4150	2870	3680	2660	3290	2520	2820
	30	16.55	4180	5150	3870	4730	3490	4270	3270	3860	3130	3430
45	9	12.34	2688	3580	2360	3330	2210	3180	1800	2240	1520	2050
	15	22.78	4720	5230	4270	4640	3660	4050	2990	3470	2420	2880
	20	24.6	5030	5540	4590	4960	3980	4360	3320	3780	2710	3220
	30	26.8	5620	6150	5180	5570	4570	4850	3930	4370	3320	3830
60	15	44.96	5760	6230	5310	5780	4790	5320	4130	4580	3380	3950
	20	46.38	6080	7420	5640	6560	5130	5700	4450	4840	3740	3980
	30	49.82	6860	8250	6560	7870	5880	6500	5060	5730	4320	4970
	40	41.34	7360	9100	6950	8650	6370	7390	5560	6380	4790	5680
80	15	72.68	7380	8430	6590	7020	5960	6870	5120	5670	4680	4850
	20	74.32	7610	8950	6870	7760	6280	7180	5440	5980	4890	5180
	30	77.68	8320	9650	7450	8460	6750	7500	5960	6480	5120	5450
	40	78.21	9050	10380	8030	9230	7160	8250	6490	7160	5580	6160
100	15	22.76	8250	10100	8170	9270	7160	8470	6450	7120	5100	5540
	20	25.98	9650	11200	8760	9870	7670	8790	6870	7480	5430	5960
	30	27.64	10450	12150	9150	10650	8280	9200	7340	7950	6060	6450
	40	29.89	11450	14050	10300	11360	8920	10100	8120	8760	6580	7120
130	20	46.98	10020	11500	10260	11300	8870	9750	7680	8270	6780	7600
	30	49.68	12050	13100	11200	12500	9870	10600	8240	9100	7800	8500
	40	51.77	13000	14200	12000	13000	10480	11710	9230	10100	8720	9260
	50	60.32	13950	15200	12720	13800	11100	12400	9780	10700	9200	9800
160	30	58.96	12600	13890	11200	12820	10860	11650	9200	10400	8120	9350
	40	61.12	13500	15850	12250	14250	11200	12870	10200	11500	9270	10400
	49	66.26	14000	16400	12700	15250	11700	15000	10800	11960	9650	10900
	60	73.21	14300	16800	12950	15800	12000	15300	11000	12190	9800	11110
180	40	59.86	16120	17860	14770	16240	12700	14760	11860	13780	10980	12680
	50	62.31	16950	18750	1500	17400	13800	15990	12600	14600	11550	13300
	65	65.99	19400	21500	18000	20010	15870	18000	14400	16700	13200	15290
	75	70.41	20370	22575	19260	21410	17130	19440	15264	17702	13860	16050
200	50	65.3	17600	19700	16980	18300	14750	17240	14390	15470	12970	14490
	60	69.61	18480	20685	18170	19581	15930	18650	15290	16395	13610	15215
	74	73.63	21000	23400	20500	22500	18300	20000	17400	18500	15400	17300
	85	80.4	22050	24570	21935	24075	19764	21600	18444	19610	16170	18165
240	60	70.21	19670	21820	18080	20585	16320	19450	15685	17079	13561	15206
	70	73.4	20650	22911	19340	22020	17630	20410	16620	18100	14230	15960
	78	77.8	21600	24000	20500	23200	19000	21700	17500	19000	14600	16500
	90	83.2	22680	25200	21935	24824	20520	23436	18550	20140	15330	17325
300	70	74.31	21060	23360	19720	22400	17980	20920	16950	18460	14510	16270
	85	80.12	22100	24500	21100	24000	19400	22500	17900	19500	15200	17080
	95	86.28	27400	32400	23300	29200	22200	27000	21100	21900	18950	20600
	105	88.78	30000	35000	25000	32000	24900	30300	23600	24300	21200	23100
350	70	76.31	21400	23800	20100	22800	18300	21300	17200	18800	14800	16590
	85	82.22	22470	24990	21500	24390	19750	23000	18250	19920	15540	17410
	95	97.37	23500	27400	23000	264000	21300	25800	19300	21100	16300	18200
	105	89.24	27025	31510	26450	303600	24495	29700	22195	24265	18745	20930

Note:

1. The data in table is acquired under 120 Pa ESP condition
2. When ESP is changed, the air flow will change in accordance. Therefore heat capacity will need to be calculated by multiplying correction factors
3. Interpolation method could be applied when no exact value can be found on above table
4. When inlet temperature beyond the range, please consult design engineer for advice

Heating Performance data

CHILLED FLOW Fan Coil Units

Air on temperature DB 20°C

Model	Water flow (L/min)	Water resistance (kPa)	Design condition: Return air DB 20°C						
			Hot water inlet temperature °C						
			40	45	50	55	60	70	80
			TH (W)						
30	9	8.81	2247	2756	3276	4017	4514	5648	6773
	15	12.86	2636	3068	3702	4295	4886	6114	7332
	20	14.21	2828	3297	3973	4604	5243	6561	7868
	30	16.55	2856	3453	4160	4851	5518	6905	8281
45	9	12.34	2573	3089	4004	4810	5273	6599	7914
	15	22.78	3192	3858	4649	5418	6171	7722	9261
	20	24.6	3843	4638	5595	6510	7415	9280	11128
	30	26.8	4158	5023	6053	7056	8027	10045	12047
60	15	44.96	3854	4659	5606	6541	7446	9318	11174
	20	46.38	4515	5460	6573	7663	8721	10913	13087
	30	49.82	5177	6261	7540	8786	9996	12509	15001
	40	51.34	6279	7582	9142	10650	12128	15177	18200
80	15	72.68	4368	5273	6354	7406	8425	10543	12644
	20	74.32	4883	5897	7103	8281	9425	11794	14144
	30	77.68	5765	6958	8382	9764	11118	13913	16685
	40	78.21	6762	8174	9849	11474	13056	16338	19593
100	15	22.76	5607	6770	8154	9497	10812	13530	16225
	20	25.98	6237	7530	9079	10578	12036	15062	18062
	30	27.64	7193	8684	10462	12185	13872	17359	20817
	40	29.89	7760	9381	11315	13174	14994	18763	22501
130	20	46.98	7130	8622	10379	12103	13770	17232	20664
	30	49.68	8085	9766	11762	13709	15606	19529	23420
	40	51.77	9303	11232	13541	15769	17952	22465	26940
	50	60.32	10133	12584	15080	16995	19380	24252	29083
160	30	58.96	10143	12251	14768	17201	19584	24507	29389
	40	61.12	11361	13624	16536	19261	21930	27443	32910
	49	66.26	11550	14248	17576	20806	22950	28720	34441
	60	73.21	11839	14960	18710	22464	25245	31592	37885
180	40	59.86	12422	14997	18075	21064	23970	29996	35971
	50	62.31	12810	15600	19240	22660	26316	32932	39492
	65	65.99	13130	16380	20488	24473	27540	34464	41329
	75	70.41	13440	17160	21632	26368	30294	37910	45462
200	50	65.3	12915	16172	19760	23330	24786	31017	37196
	60	69.61	13073	16848	21008	24720	27642	34591	41482
	74	73.63	13860	17888	22360	27192	30600	38293	45921
	85	80.4	14805	18824	23868	29355	32946	41229	49441
240	60	70.21	13755	17888	22256	26574	29580	37016	44390
	70	73.4	14385	18824	23712	28737	32538	40718	48829
	78	77.8	14910	19718	25168	30900	35700	44675	53574
	90	83.2	15855	20852	26884	33475	39270	49142	58932
300	70	74.31	14805	19968	25480	34505	37128	46462	55717
	85	80.12	15540	22464	27144	37183	40851	51121	61304
	95	86.28	16170	22048	28808	40170	44166	55269	66279
	105	88.78	17010	23192	30680	43260	48960	61269	73473
350	70	76.31	15225	21840	26312	35638	37944	47483	56942
	85	82.22	15750	23036	27976	38419	40800	51057	61228
	95	97.37	16695	24180	29838	41509	45900	57439	68881
	105	89.24	17693	25376	31782	44805	49164	61524	73779

Note:

1. The data in table is acquired under 120 Pa ESP condition
2. When ESP is changed, the air flow will change in accordance. Therefore heat capacity will need to be calculated by multiplying correction factors
3. Interpolation method could be applied when no exact value can be found on above table
4. When inlet temperature beyond the range, please consult design engineer for advice

Heating Performance data

Air on temperature DB 21°C

Model	Water flow (L/min)	Water resistance (kPa)	Indoor condition: Return air temp. DB 21°C				
			Hot water inlet temp. °C (coil)				
			40	45	50	55	60
			TH W				
30	9	8.81	2140	2650	3150	3900	4425
	15	12.86	2510	2950	3560	4170	4790
	20	14.21	2693	3170	3820	4470	5140
	30	16.55	2720	3320	4000	4710	5410
45	9	12.34	2450	2970	3850	4670	5170
	15	22.78	3040	3710	4470	5260	6050
	20	24.6	3660	4460	5380	6320	7270
	30	26.8	3960	4830	5820	6850	7870
60	15	44.96	3670	4480	5390	6350	7300
	20	46.38	4300	5250	6320	7440	8550
	30	49.82	4930	6020	7250	8530	9800
	40	51.34	5980	7290	8790	10340	11890
80	15	72.68	4160	5070	6110	7190	8260
	20	74.32	4650	5670	6830	8040	9240
	30	77.68	5490	6690	8060	9480	10900
	40	78.21	6440	7860	9470	11140	12800
100	15	22.76	5340	6510	7840	9220	10600
	20	25.98	5940	7240	8730	10270	11800
	30	27.64	6850	8350	10060	11830	13600
	40	29.89	7390	9020	10880	12790	14700
130	20	46.98	6790	8290	9980	11750	13500
	30	49.68	7700	9390	11310	13310	15300
	40	51.77	8860	10800	13020	15310	17600
	50	60.32	9650	12100	14500	16500	19000
160	30	58.96	9660	11780	14200	16700	19200
	40	61.12	10820	13100	15900	18700	21500
	49	66.26	11000	13700	16900	20200	22500
	60	73.21	11275	14385	17990	21810	24750
180	40	59.86	11830	14420	17380	20450	23500
	50	62.31	12200	15000	18500	22000	25800
	65	65.99	12505	15750	19700	23760	27000
	75	70.41	12800	16500	20800	25600	29700
200	50	65.3	12300	15550	19000	22650	24300
	60	69.61	12450	16200	20200	24000	27100
	74	73.63	13200	17200	21500	26400	30000
	85	80.4	14100	18100	22950	28500	32300
240	60	70.21	13100	17200	21400	25800	29000
	70	73.4	13700	18100	22800	27900	31900
	78	77.8	14200	18960	24200	30000	35000
	90	83.2	15100	20050	25850	32500	38500
300	70	74.31	14100	19200	24500	33500	36400
	85	80.12	14800	21600	26100	36100	40050
	95	86.28	15400	21200	27700	39000	43300
	105	88.78	16200	22300	29500	42000	48000
350	70	76.31	14500	21000	25300	34600	37200
	85	82.22	15000	22150	26900	37300	40000
	95	97.37	15900	23250	28690	40300	45000
	105	89.24	16850	24400	30560	43500	48200

Note:

1. The data in table is acquired under 120 Pa ESP condition
2. When ESP is changed, the air flow will change in accordance. Therefore heat capacity will need to be calculated by multiplying correction factors
3. Interpolation method could be applied when no exact value can be found on above table
4. When inlet temperature beyond the range, please consult design engineer for advice

Heating Performance data

Air on temperature DB 22°C

CHILLED FLOW Fan Coil Units

Model	Water flow (L/min)	Water resistance (kPa)	Design condition: Return air DB 22°C						
			Hot water inlet temperature °C						
			40	45	50	55	60	70	80
			TH (w)						
30	9	8.81	1926	2433	2917	3647	4195	5239	6280
	15	12.86	2259	2708	3297	3899	4541	5671	6798
	20	14.21	2424	2910	3537	4179	4873	6086	7295
	30	16.55	2448	3048	3704	4404	5129	6405	7678
45	9	12.34	2205	2726	3565	4366	4901	6121	7337
	15	22.78	2736	3406	4139	4918	5735	7163	8586
	20	24.6	3294	4094	4982	5909	6892	8607	10318
	30	26.8	3564	4434	5389	6405	7461	9318	11169
60	15	44.96	3303	4113	4991	5937	6920	8643	10360
	20	46.38	3870	4820	5852	6956	8105	10123	12134
	30	49.82	4437	5526	6714	7976	9290	11603	13908
	40	51.34	5382	6692	8140	9668	11272	14077	16874
80	15	72.68	3744	4654	5658	6723	7830	9779	11723
	20	74.32	4185	5205	6325	7517	8760	10940	13113
	30	77.68	4941	6141	7464	8864	10333	12905	15469
	40	78.21	5796	7215	8769	10416	12134	15155	18166
100	15	22.76	4806	5976	7260	8621	10049	12550	15044
	20	25.98	5346	6646	8084	9602	11186	13971	16747
	30	27.64	6165	7665	9316	11061	12893	16102	19301
	40	29.89	6651	8280	10075	11959	13936	17404	20862
130	20	46.98	6111	7610	9241	10986	12798	15983	19159
	30	49.68	6930	8620	10473	12445	14504	18115	21714
	40	51.77	7974	9914	12057	14315	16685	20838	24978
	50	60.32	8685	11108	13427	15428	18012	22495	26965
160	30	58.96	8694	10814	13149	15615	18202	22732	27249
	40	61.12	9738	12026	14723	17485	20382	25455	30513
	49	66.26	9900	12577	15649	18887	21330	26639	31932
	60	73.21	10148	13205	16659	20392	23463	29303	35125
180	40	59.86	10647	13238	16094	19121	22278	27823	33351
	50	62.31	10980	13770	17131	20570	24458	30546	36616
	65	65.99	11255	14459	18242	22216	25596	31967	38319
	75	70.41	11520	15147	19261	23936	28156	35164	42151
200	50	65.3	11070	14275	17594	21178	23036	28770	34487
	60	69.61	11205	14872	18705	22440	25691	32085	38461
	74	73.63	11880	15790	19909	24684	28440	35519	42576
	85	80.4	12690	16616	21252	26648	30620	38242	45840
240	60	70.21	11790	15790	19816	24123	27492	34335	41157
	70	73.4	12330	16616	21113	26087	30241	37768	45273
	78	77.8	12780	17405	22409	28050	33180	41439	49672
	90	83.2	13590	18406	23937	30388	36498	45582	54640
300	70	74.31	12690	17626	22687	31323	34507	43096	51659
	85	80.12	13320	19829	24169	33754	37967	47417	56839
	95	86.28	13860	19462	25650	36465	41048	51265	61452
	105	88.78	14580	20471	27317	39270	45504	56830	68122
350	70	76.31	13050	19278	23428	32351	35266	44043	52795
	85	82.22	13500	20334	24909	34876	37920	47358	56768
	95	97.37	14310	21344	26567	37681	42660	53278	63864
	105	89.24	15165	22399	28299	40673	45694	57067	68406

Note:

1. The data in table is acquired under 120 Pa ESP condition
2. When ESP is changed, the air flow will change in accordance. Therefore heat capacity will need to be calculated by multiplying correction factors
3. Interpolation method could be applied when no exact value can be found on above table
4. When inlet temperature beyond the range, please consult design engineer for advice

Heating Performance data (1 Rows only)

Air on temperature DB 20°C

Model	Water flow (L/min)	Water resistance (kPa)	Design condition: Return air DB 20°C						
			Hot water inlet temperature °C						
			40	45	50	55	60	70	80
			TH (W)						
30	5	11	1382	1695	2015	2470	2776	3474	4166
	10	16	1621	1887	2277	2641	3005	3760	4509
	13	20	1739	2028	2443	2832	3224	4035	4839
	20	26	1756	2123	2558	2984	3394	4247	5093
45	5	12	1582	1900	2462	2958	4143	4358	4867
	10	18	1963	2373	2859	3332	4395	4749	5695
	13	22	2363	2853	3441	4003	4560	5707	6844
	20	28	2557	3089	3722	4339	4937	6178	7409
60	5	16	2370	2865	3447	4022	4779	5731	6872
	10	20	2777	3358	4042	4713	5663	6712	8049
	13	26	3184	3850	4637	5403	6148	7693	9225
	20	35	3862	4663	5622	6550	7459	9334	11193
80	5	25	2686	3243	3908	4555	5381	6484	7776
	10	33	3003	3627	4368	5093	6496	7253	8698
	13	40	3545	4279	5155	6005	6838	8557	10261
	20	48	4159	5027	6057	7057	8029	10048	12050
100	10	16	3286	3967	4778	5565	7336	7929	9508
	13	20	3655	4412	5320	6199	8393	8826	10584
	20	26	4215	5089	6131	7140	8529	10173	12199
	25	35	4547	5497	6631	7720	8786	10995	13186
130	10	25	4178	5052	6082	7092	8069	10098	12109
	13	33	4738	5723	6893	8034	9145	11444	13724
	20	40	5452	6582	7935	9241	10920	13165	15787
	25	48	5938	7374	8837	9959	11357	14212	17043
160	10	28	5944	7179	8654	10080	11476	14361	17222
	13	35	6658	7984	9690	11287	12851	16082	19285
	20	45	6768	8349	10300	12192	13449	16830	20182
	25	53	6938	8767	10964	13164	14794	18513	22200
180	13	25	6745	8143	9815	11437	13016	16288	19532
	20	33	6956	8471	10447	12304	14290	17882	21444
	25	40	7130	8894	11125	13289	15954	18714	22441
	30	48	7298	9318	11746	14318	16450	20585	24686
200	13	28	7013	8781	10730	12668	13459	16842	20197
	20	35	7098	9148	11407	13423	15010	18783	22525
	25	45	7526	9713	12141	14765	16616	20793	24935
	30	53	8039	10221	12960	15940	20890	22387	26847
240	13	30	7033	9146	11379	13587	15124	18926	22697
	20	40	7355	9625	12124	14693	16637	20819	24966
	25	48	7623	10082	12868	15799	18253	22842	27393
	30	55	8107	10662	13746	17116	21379	25127	30132
300	13	32	7570	10210	13028	17642	18984	23756	28488
	20	43	7946	11486	13879	19012	20887	26138	31345
	25	53	8268	11273	14730	20539	22582	28259	33888
	30	58	8697	11858	15687	22119	25033	31327	37567
350	13	35	7785	11167	13453	18222	19401	24278	29114
	20	45	8053	11778	14304	19644	20861	26106	31306
	25	55	8536	12363	15256	21224	23469	29369	35219
	30	60	9046	12975	16250	22909	25138	31457	37723

Note:

1. The data in table is acquired under 120 Pa ESP condition
2. When ESP is changed, the air flow will change in accordance. Therefore heat capacity will need to be calculated by multiplying correction factors
3. Interpolation method could be applied when no exact value can be found on above table
4. When inlet temperature beyond the range, please consult design engineer for advice

Heating Performance data (1 Rows only)

CHILLED FLOW Fan Coil Units

Air on temperature DB 22°C

Model	Water flow (L/min)	Water resistance (kPa)	Design condition: Return air DB 22°C						
			Hot water inlet temperature °C						
			40	45	50	55	60	70	80
			TH (W)						
30	5	11	1184	1496	1793	2242	2579	3221	3861
	10	16	1389	1665	2027	2397	2792	3487	4179
	13	20	1490	1789	2175	2570	2996	3741	4485
	20	26	1505	1874	2277	2707	3153	3938	4720
45	5	12	1356	1676	2192	2684	3013	3763	4511
	10	18	1682	2094	2545	3024	3526	4404	5279
	13	22	2025	2517	3063	3633	4237	5292	6343
	20	28	2191	2726	3313	3938	4587	5729	6867
60	5	16	2031	2528	3069	3650	4255	5314	6369
	10	20	2379	2963	3598	4277	4983	6224	7460
	13	26	2728	3398	4127	4903	5712	7133	8551
	20	35	3309	4114	5004	5944	6930	8655	10374
80	5	25	2302	2861	3478	4133	4814	6012	7207
	10	33	2573	3200	3888	4622	5385	6726	8062
	13	40	3038	3776	4589	5449	6353	7934	9511
	20	48	3563	4436	5391	6404	7460	9317	11168
100	10	16	2817	3503	4255	5053	5890	7356	8817
	13	20	3133	3895	4738	5628	6556	8188	9815
	20	26	3613	4493	5460	6483	7556	9437	11312
	25	35	3898	4853	5905	7009	8168	10201	12227
130	10	25	3582	4460	5416	6439	7501	9368	11229
	13	33	4062	5052	6138	7294	8501	10617	12727
	20	40	4674	5811	7066	8390	9779	12213	14640
	25	48	5090	6510	7870	9042	10557	13184	15804
160	10	28	5096	6338	7707	9152	10668	13323	15971
	13	35	5707	7048	8629	10248	11946	14919	17884
	20	45	5802	7371	9172	11070	12502	15613	18715
	25	53	5947	7740	9764	11952	13752	17174	20587
180	13	25	5781	7188	8739	10383	12097	15108	18110
	20	33	5962	7477	9302	11170	13281	16587	19882
	25	40	6111	7851	9906	12063	13899	17358	20807
	30	48	6255	8225	10459	12997	15288	19094	22888
200	13	28	6011	7751	9554	11500	12509	15622	18726
	20	35	6084	8075	10157	12185	13950	17422	20884
	25	45	6451	8574	10811	13403	15443	19287	23119
	30	53	6891	9022	11540	14470	16627	20765	24891
240	13	30	6028	8073	10132	12334	14057	17555	21044
	20	40	6304	8496	10795	13338	15462	19311	23148
	25	48	6534	8899	11458	14342	16965	21188	25397
	30	55	6949	9411	12239	15537	18661	23306	27937
300	13	32	6488	9012	11600	16015	17644	22035	26413
	20	43	6811	10138	12357	17258	19413	24245	29062
	25	53	7087	9951	13115	18645	20988	26212	31420
	30	58	7455	10467	13967	20079	23266	29057	34831
350	13	35	6672	9857	11979	16541	18031	22519	26994
	20	45	6903	10397	12736	17832	19388	24214	29026
	25	55	7317	10913	13584	19266	21812	27241	32654
	30	60	7754	11453	14469	20796	23363	29178	34976

Note:

1. The data in table is acquired under 120 Pa ESP condition
2. When ESP is changed, the air flow will change in accordance. Therefore heat capacity will need to be calculated by multiplying correction factors
3. Interpolation method could be applied when no exact value can be found on above table
4. When inlet temperature beyond the range, please consult design engineer for advice

Correction Factor of Total/Sensible Cooling Capacity

CF: Correction Factor
Q: Air Volume
TH: Total Heat
SH: Sensible Heat

Speed: SH – ESP : 120Pa

Model	TH/SH	ESP(Pa)											
		60		80		100		120		140		150	
		CF	Q(l/s)	CF	Q(l/s)	CF	Q(l/s)	CF	Q(l/s)	CF	Q(l/s)	CF	Q(l/s)
30	TH	1.14	195	1.1	181	1.05	160	1	143	0.89	122	0.76	108
	SH	1.16		1.11		1.06		1		0.83		0.68	
45	TH	1.14	270	1.1	255	1.04	235	1	211	0.89	185	0.83	170
	SH	1.16		1.12		1.06		1		0.83		0.77	
60	TH	1.14	390	1.1	345	1.05	315	1	281	0.88	238	0.77	216
	SH	1.15		1.1		1.06		1		0.83		0.70	
80	TH	1.13	500	1.09	445	1.05	415	1	375	0.89	338	0.86	319
	SH	1.15		1.1		1.06		1		0.83		0.76	
100	TH	1.15	536	1.1	512	1.06	490	1	468	0.92	455	0.88	435
	SH	1.17		1.11		1.07		1		0.9		0.86	
130	TH	1.14	670	1.09	661	1.05	640	1	609	0.92	570	0.87	545
	SH	1.16		1.11		1.06		1		0.9		0.86	
160	TH	1.12	832	1.09	810	1.05	790	1	749	0.92	710	0.87	668
	SH	1.15		1.11		1.06		1		0.9		0.86	
180	TH	1.13	1012	1.08	988	1.05	925	1	843	0.88	718	0.79	640
	SH	1.15		1.1		1.06		1		0.84		0.71	
200	TH	1.13	1212	1.08	1142	1.05	1023	1	936	0.88	820	0.79	760
	SH	1.15		1.1		1.06		1		0.83		0.76	
240	TH	1.12	1410	1.07	1325	1.05	1230	1	1124	0.91	1030	0.83	938
	SH	1.15		1.09		1.06		1		0.84		0.74	
300	TH	1.12	1503	1.07	1450	1.05	1435	1	1405	0.92	1340	0.86	1280
	SH	1.14		1.09		1.06		1		0.84		0.80	
350	TH	1.12	1725	1.07	1690	1.05	1560	1	1639	0.92	1568	0.87	1487
	SH	1.14		1.09		1.06		1		0.85		0.81	

Note:

1. The data in table is acquired under 120 Pa ESP condition
2. When ESP is changed, the air flow will change in accordance. Therefore heat capacity will need to be calculated by multiplying correction factors
3. Interpolation method could be applied when no exact value can be found on above table
4. When inlet temperature beyond the range, please consult design engineer for advice

Correction Factor of Total/Sensible Cooling Capacity

CF: Correction Factor
Q: Air Volume
TH: Total Heat
SH: Sensible Heat

Speed: HH - ESPO :100Pa

Model	TH/SH	ESP(Pa)											
		40		60		80		100		120		140	
		CF	Q(l/s)	CF	Q(l/s)	CF	Q(l/s)	CF	Q(l/s)	CF	Q(l/s)	CF	Q(l/s)
30	TH	1.06	165	1.02	158	1	145	0.9	130	0.76	110	0.73	88
	SH	1.07		1.03		1		0.85		0.68		0.66	
45	TH	1.03	230	1.02	223	1	210	0.9	191	0.83	170	0.73	148
	SH	1.04		1.04		1		0.84		0.77		0.66	
60	TH	1.04	320	1.03	303	1	280	0.9	256	0.78	220	0.71	182
	SH	1.05		1.04		1		0.84		0.71		0.63	
80	TH	1.04	420	1.03	405	0.99	370	0.9	341	0.82	308	0.73	278
	SH	1.05		1.04		0.93		0.83		0.74		0.66	
100	TH	1.05	478	1.01	460	0.98	448	0.9	425	0.84	405	0.76	375
	SH	1.06		1.02		0.93		0.85		0.75		0.69	
130	TH	1.06	680	1.05	650	0.97	590	0.9	555	0.83	515	0.79	470
	SH	1.08		1.07		0.92		0.84		0.74		0.71	
160	TH	1.03	740	0.98	715	0.96	698	0.9	682	0.84	640	0.79	585
	SH	1.05		0.99		0.92		0.82		0.75		0.7	
180	TH	1.03	860	0.99	830	0.96	800	0.91	767	0.8	661	0.78	470
	SH	1.03		0.99		0.92		0.86		0.72		0.71	
200	TH	1.06	1050	1.03	988	0.96	910	0.91	852	0.83	790	0.71	680
	SH	1.08		1.04		0.92		0.85		0.75		0.65	
240	TH	1.04	1210	1.02	1157	0.95	1099	0.91	1023	0.82	930	0.72	798
	SH	1.06		1.03		0.92		0.84		0.73		0.66	
300	TH	1.04	1370	0.98	1350	0.95	1320	0.91	1278	0.84	1220	0.77	1140
	SH	1.05		0.98		0.92		0.83		0.79		0.71	
350	TH	1.06	1580	0.97	1550	0.95	1528	0.91	1492	0.85	1410	0.74	1322
	SH	1.07		0.98		0.92		0.82		0.79		0.7	

Note:

1. The data in table is acquired under 120 Pa ESP condition
2. When ESP is changed, the air flow will change in accordance. Therefore heat capacity will need to be calculated by multiplying correction factors
3. Interpolation method could be applied when no exact value can be found on above table
4. When inlet temperature beyond the range, please consult design engineer for advice

Correction Factor of Total/Sensible Cooling Capacity

CF: Correction Factor
Q: Air Volume
TH: Total Heat
SH: Sensible Heat

Speed: H – ESP : 80Pa

Model	TH/SH	ESP(Pa)											
		20		40		60		80		100		120	
		CF	Q(l/s)	CF	Q(l/s)	CF	Q(l/s)	CF	Q(l/s)	CF	Q(l/s)	CF	Q(l/s)
30	TH	1.04	155	0.99	141	0.9	130	0.83	119	0.75	100	0.73	85
	SH	1.05		0.98		0.85		0.77		0.67		0.66	
45	TH	1.02	221	1	210	0.95	200	0.83	175	0.75	158	0.73	140
	SH	1.04		1		0.91		0.77		0.66		0.65	
60	TH	1	280	0.93	268	0.91	246	0.84	233	0.72	202	0.71	182
	SH	1		0.88		0.85		0.76		0.64		0.63	
80	TH	1.01	387	0.97	365	0.91	345	0.84	311	0.73	280	0.72	258
	SH	1.01		0.92		0.84		0.76		0.66		0.65	
100	TH	1.01	460	0.96	438	0.87	418	0.83	388	0.75	358	0.74	299
	SH	1.02		0.91		0.83		0.74		0.68		0.67	
130	TH	0.99	600	0.95	570	0.87	540	0.82	505	0.78	480	0.76	435
	SH	0.93		0.88		0.86		0.73		0.7		0.69	
160	TH	0.88	675	0.85	650	0.84	635	0.82	621	0.79	588	0.76	509
	SH	0.87		0.77		0.75		0.73		0.7		0.69	
180	TH	0.99	835	0.96	801	0.9	750	0.82	699	0.79	648	0.76	398
	SH	0.99		0.92		0.85		0.73		0.71		0.69	
200	TH	1.01	950	0.94	900	0.91	856	0.82	778	0.72	687	0.71	576
	SH	1.02		0.9		0.85		0.74		0.66		0.65	
240	TH	1	1128	0.94	1088	0.89	1001	0.82	934	0.75	858	0.72	690
	SH	1		0.9		0.85		0.73		0.67		0.66	
300	TH	0.88	1245	0.84	1218	0.83	1198	0.82	1164	0.76	1122	0.74	1065
	SH	0.85		0.79		0.78		0.73		0.71		0.68	
350	TH	0.86	1450	0.85	1400	0.85	1378	0.82	1361	0.75	1338	0.73	1255
	SH	0.81		0.79		0.78		0.73		0.7		0.68	

Note:

1. The data in table is acquired under 120 Pa ESP condition
2. When ESP is changed, the air flow will change in accordance. Therefore heat capacity will need to be calculated by multiplying correction factors
3. Interpolation method could be applied when no exact value can be found on above table
4. When inlet temperature beyond the range, please consult design engineer for advice

Correction Factor of Total/Sensible Cooling Capacity

CF: Correction Factor
Q: Air Volume
TH: Total Heat
SH: Sensible Heat

Speed: M – ESP : 60Pa

Model	TH/SH	ESP(Pa)											
		0		20		40		60		80		100	
		CF	Q(l/s)	CF	Q(l/s)	CF	Q(l/s)	CF	Q(l/s)	CF	Q(l/s)	CF	Q(l/s)
30	TH	0.97	135	0.89	126	0.83	115	0.75	107	0.74	99	0.73	85
	SH	0.95		0.83		0.77		0.68		0.67			
45	TH	0.97	208	0.95	196	0.85	180	0.75	158	0.73	142	0.71	120
	SH	0.95		0.91		0.79		0.66		0.65			
60	TH	0.91	260	0.91	251	0.84	231	0.74	211	0.71	197	0.7	170
	SH	0.85		0.85		0.76		0.65		0.64			
80	TH	0.89	332	0.86	322	0.84	311	0.73	281	0.71	260	0.7	235
	SH	0.83		0.78		0.76		0.66		0.64			
100	TH	0.83	393	0.82	380	0.8	365	0.74	351	0.72	340	0.71	312
	SH	0.74		0.73		0.71		0.67		0.65			
130	TH	0.87	548	0.83	512	0.79	488	0.74	457	0.72	428	0.71	390
	SH	0.86		0.74		0.71		0.66		0.65			
160	TH	0.82	620	0.8	598	0.78	580	0.73	562	0.71	510	0.7	420
	SH	0.73		0.71		0.7		0.63		0.62			
180	TH	0.88	718	0.82	695	0.79	650	0.75	632	0.72	554	0.7	320
	SH	0.84		0.73		0.71		0.68		0.66			
200	TH	0.9	880	0.89	826	0.81	771	0.74	702	0.71	620	0.7	500
	SH	0.85		0.84		0.73		0.67		0.63			
240	TH	0.88	981	0.82	932	0.79	895	0.73	843	0.71	768	0.7	640
	SH	0.8		0.73		0.7		0.66		0.64			
300	TH	0.77	1132	0.75	1109	0.74	1075	0.73	1053	0.71	1000	0.7	890
	SH	0.72		0.7		0.69		0.66		0.64			
350	TH	0.76	1355	0.74	1278	0.73	1255	0.73	1228	0.71	1169	0.7	1108
	SH	0.71		0.69		0.68		0.65		0.64			

Note:

1. The data in table is acquired under 120 Pa ESP condition
2. When ESP is changed, the air flow will change in accordance. Therefore heat capacity will need to be calculated by multiplying correction factors
3. Interpolation method could be applied when no exact value can be found on above table
4. When inlet temperature beyond the range, please consult design engineer for advice

Correction Factor

If the air inlet temp beyond this condition: return air temp. DB 27°C / 19.5°C (cooling), return air temp. DB 21°C (heating). Please use the following correction factor.

Correction factor of Cooling Total Heating

Water inlet temp. °C	Air inlet condition				
	DB22	DB24	DB27	DB28	DB30
	15WB	17WB	19.5WB	21WB	23WB
5	0.645	0.815	1	1.2	1.42
6	0.625	0.805	1	1.21	1.44
7	0.6	0.795	1	1.22	1.47
8	---	0.78	1	1.24	1.5
9	---	0.76	1	1.25	1.55

Correction factor of Cooling Sensible Heating

Water inlet temp. °C	Air inlet condition				
	DB22	DB24	DB27	DB28	DB30
	15WB	17WB	19.5WB	21WB	23WB
5	0.81	0.9	1	1.09	1.19
6	0.8	0.9	1	1.1	1.2
7	0.79	0.89	1	1.1	1.21
8	0.78	0.89	1	1.11	1.22
9	0.765	0.89	1	1.11	1.23

Correction factor of Heating Capacity

Water inlet temp. °C	Air inlet condition					
	DB0	DB5	DB10	DB15	DB20	DB21
40	2.22	1.94	1.67	1.39	1.11	1
45	1.95	1.74	1.52	1.3	1.08	1
50	1.78	1.6	1.43	1.25	1.07	1
55	1.66	1.51	1.36	1.21	1.06	1
60	1.58	1.45	1.31	1.18	1.05	1

*Correction factor for different air flow rate

Note:

1. The data in table is acquired under 120 Pa ESP condition
2. When ESP is changed, the air flow will change in accordance. Therefore heat capacity will need to be calculated by multiplying correction factors
3. Interpolation method could be applied when no exact value can be found on above table
4. When inlet temperature beyond the range, please consult design engineer for advice

CHILLED FLOW Fan Coil Units

Specification and Type

- Five mounting methods (ceiling type concealed/exposed, floor type concealed/exposed, cassette type)
- Models cover air volume from 94 – 661 l/s
- Cooling Capacity 1.8 – 12.6 kW
- Heating Capacity 2.7 – 20.0 kW
- Copper tube, aluminium fin, cross banding radiating pipe
- 2 row, 3 rows tube 2 pipe system and 2+1, 3+1 rows 4 pipe system
- Three types of units: standard, medium and high static pressure type
- Centrifugal multiblade impeller makes for better balance and low noise
- 3 speed fan
- EC Motor available
- Insulation : 10mm Polyethylene Foam Insulation (PE)

Nomenclature

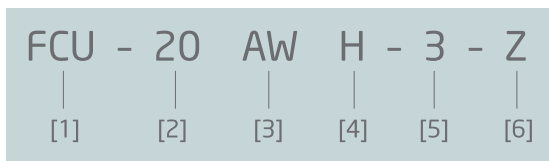

[1] Fan coil

[2] Air volume code

20, 30, 40, 50, 40, 70, 80, 100, 120, 140

Air volume = air volume code x 4.7 l/s

[3] Type

AW: ceiling concealed

AL: floor concealed

ML: floor exposed

CE: ceiling exposed

XD – A: ceiling cassette

[4] Static pressure

Standard type: S (12 Pa)

Medium static pressure type: M (30 Pa)

High static pressure type: HD (50 Pa)

[5] Row of tube

2 + 1: 3 rows / 4 pipe

3 + 1: 4 rows / 4 pipe

2: 2 rows / 2 pipe

3: 3 rows / 2 pipe

[6] Direction of water inlet facing air outlet

Z: left type

Y: right type

Cooling capacity correction table for medium or low air velocity

Model	20	30	40	50	60	70	80	100	120	140
Medium	0.87	0.88	0.88	0.88	0.88	0.85	0.88	0.88	0.88	0.88
Low	0.80	0.76	0.78	0.78	0.70	0.70	0.76	0.70	0.71	0.72

Installation and instruction

1. Rotate the impeller before mounting to assure free movement
2. Install valves to water in and out pipes. Water pipes should be kept insulated.
3. The weight of air and water pipes that are connected to the unit should not be supported by the unit.
4. Discharge all water after pressure testing. Especially if installation is occurring in frost/icy winter conditions.
5. Open the air vent before using and then close the valve to expel air and assure water flow.
6. Clean the filter periodically
7. The bolt hole for the earth on the casing should be connected with protection system.
8. The electrical and pipe should be connected according to the unit's drawing/specification, in order to avoid damaging the unit.
9. For XD model type, in winter heating mode, we recommend the height between the decorating floor and the ground floor be no more than 3 meters.

Ceiling Concealed Type

(AW-2, AWH-2, AW-3, AWH-3)

1. Drain connection 3/4MPT
2. Terminal box
3. Water outlet 3/4FPT
4. Water inlet 3/4FPT

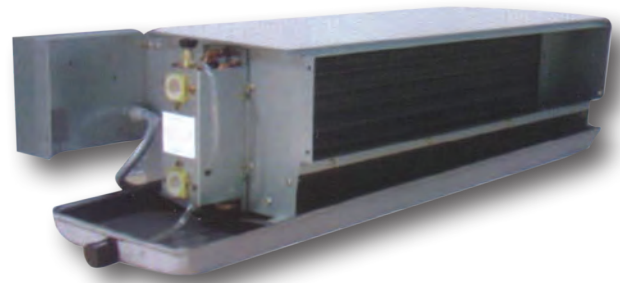

Note:

1. M-motor quantity
2. F-fan quantity
3. Return air box, rear or down can be selected
4. Rear or down return air box can be changed on the spot
5. The air inlet dimension is 205(12pa) / 205(30pa) / 225(50pa)
6. Drain pan available in standard and extended

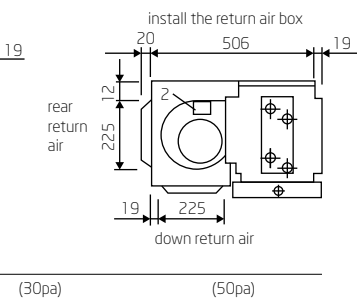
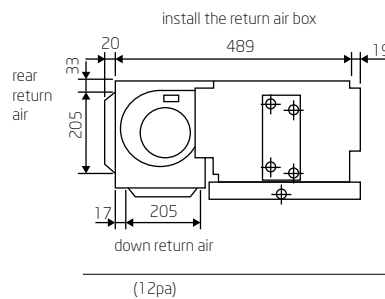
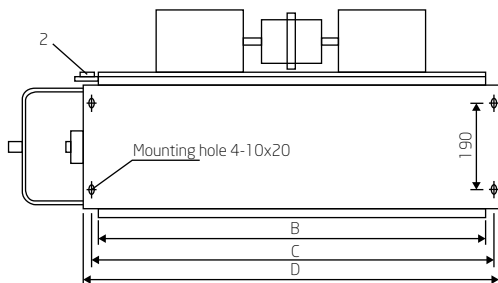
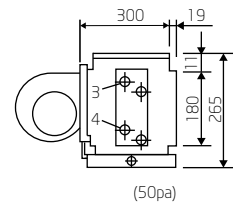
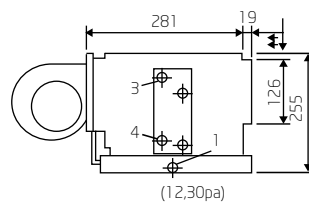
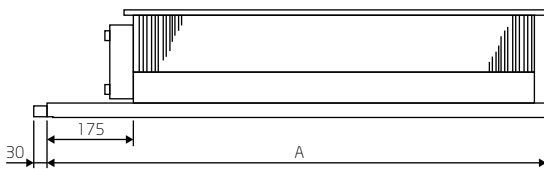

Dimension

Model	20-2 20-3	30-2 30-3	40-2 40-3	50-2 50-3	60-2 60-3	70-2 70-3	80-2 80-3	100-2 100-3	120-2 120-3	140-2 140-3
A	745	845	945	1070	1165	1260	1450	1640	1905	2140
B	520	620	720	845	940	1035	1225	1415	1680	1915
C	550	650	750	875	970	1065	1255	1445	1710	1945
D	580	680	780	905	1000	1095	1285	1475	1740	1975
E	480	580	680	805	900	995	1185	1375	1640	1875
M	1	1	1	1	1	1	2	2	2	2
F	1	2	2	2	2	2	4	4	4	4

Ceiling Concealed Type

Concealed 3 rows (2 pipe system)

Model		20	30	40	50	60	70	80	100	120	140
Rated air flow (l/s)	H	94	144	192	236	283	330	378	472	566	661
	M	76	104	146	179	208	255	264	349	469	495
	L	57	76	113	132	151	197	203	269	316	415
Cooling capacity (kW)	H	2.1	3.0	4.0	4.8	5.7	6.5	7.5	9.2	10.8	12.6
Heating capacity (kW)	H	3.3	4.8	6.8	8.1	9.2	9.9	12.0	15.1	17.2	20.0
Water flow rate (l/s)	H	0.1	0.14	0.19	0.23	0.27	0.31	0.37	0.44	0.52	0.61
Water resistance (kPa)	H	5	9	18	21	38	26	39	24	35	48
Noise (dBA)	12 Pa	35	36	39	41	43.5	45	44	46	48	50
	30 Pa	38	39	40	43	46	47.5	46.5	48	49	52
	50 Pa	40	42	44	47	49	50	50	52	53	56
Input power (W)	12 Pa	31	46	62	75	94	123	126	150	186	228
	30 Pa	43	54	71	86	108	140	142	171	212	253
	50 Pa	46	65	86	102	118	170	174	210	250	300
Weight (kg)	Horizontal 12 Pa	15	15	16.5	18	19	23	28	31	34	40
	Horizontal 30 Pa	15	15	16.5	18	20	23.5	28	31.5	35.5	41.5
	Horizontal 50 Pa	16.5	17	19	21	22	26	31	34	40	49

2+1 rows and 3+1 rows (4 pipe system)

Model		20	30	40	50	60	70	80	100	120	140
Rated air flow (l/s)	H	94	143	189	236	287	331	378	472	567	661
	M	80	113	144	179	207	256	271	351	449	484
	L	58	81	110	132	156	97	204	267	314	414
Cooling capacity (2 rows) kW	H	1.8	2.7	3.6	4.4	5.5	6.2	7.1	8.8	10.3	12.0
Cooling capacity (3 rows) kW	H	2.1	3.0	4.0	4.8	5.7	6.5	7.8	9.2	10.8	12.9
Heating capacity (1 row) kW	H	2.4	3.3	3.9	4.6	5.1	6.2	7.3	7.7	8.1	8.5
Power Supply		220V/1Ph/50Hz									
Water flow (l/s)	H	0.1	0.14	0.19	0.23	0.27	0.31	0.37	0.44	0.52	0.61
Water resistance	H	5	9	18	21	38	26	39	24	35	48
Noise (dBA)	12 Pa	35	36	39	41	43.5	45	44	46	48	50
	30 Pa	38	39	40	43	46	47.5	46.5	48	49	52
Input Power	12 Pa	31	46	62	75	94	123	126	150	189	228
	30 Pa	43	54	71	86	108	140	142	171	212	253
Fan Type	Double inlet fan										
Motor	Capacitance single phase motor										
Coil Type	Cross coils										
Water inlet and outlet	3/4FPT										
Condenser water	3/4FPT										
Weight (kg)	12 Pa	14	16	18	19.5	21	25	31	34	38	44
	30 Pa	14	16	18	19.5	22	25.5	31	34	39.5	44.5

Note:

- Nominal condition is based on Australian standard/T19232-2003.
Cooling: DB 27°C / 19.5°C WB
Chilled water inlet temp 7°C water temp rise 5°C
Heating: DB 21°C chilled water inlet temp 60°C
Water flow rate is the same as cooling.
- Standard working pressure of fan coil is 1.8 Mpa, if the need is over 1.8 Mpa, please indicate when ordering.

Floor Concealed Type

(AL-2, AL-3)



1. Drain connection 3/4 MPT
2. Filter
3. Water outlet 3/4 FPT
4. Water inlet 3/4 FPT

Note:

1. M - motor quantity
2. F - fan quantity

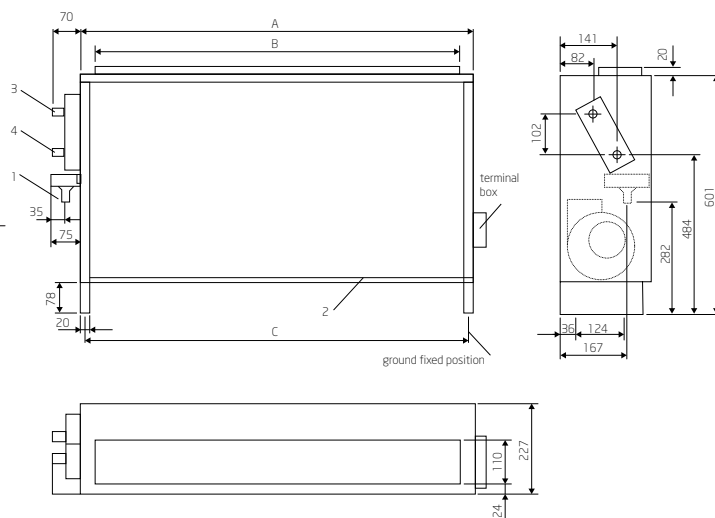

Dimension

Model	20-2 20-3	30-2 30-3	40-2 40-3	50-2 50-3	60-2 60-3	70-2 70-3	80-2 80-3	100-2 100-3	140
A	600	695	790	885	980	1075	1265	1455	1740
B	530	625	720	815	910	1005	1195	1385	1670
C	580	675	770	865	960	1055	1245	1435	1720
M	1	1	1	1	1	2	2	2	2
F	1	2	2	2	2	3	3	4	4

FCU-AL-2 (2 rows, 2 pipe system)

Model		20	30	40	50	60	70	80	100	120	140
Rated air flow (l/s)	H	97	142	189	236	283	331	378	472	567	661
	M	74	103	144	179	207	256	271	351	449	494
	L	58	74	114	132	156	197	204	267	314	414
Cooling (kW)		1.77	2.64	3.55	4.42	5.45	6.16	7.1	8.75	10.26	11.98
Heating (kW)		2.66	3.98	5.32	6.72	8.18	9.19	10.56	12.97	15.39	17.96
Water flow (l/s)		0.08	0.15	0.17	0.21	0.26	0.29	0.34	0.42	0.49	0.57
Water resistance(kPa)		4	8	17	21	37	25	39	24	33	48
Noise (dBA)		35	36	39	41	43.5	45	44	46	48	50
Power Input (w)		31	46	62	75	94	123	126	150	189	228
Weight (kg)		15	17	19	20.5	22.5	26.5	32	36	42	49

FCU-AL-3 (3 rows, 2 pipe system)

Model		20	30	40	50	60	70	80	100	120	140
Rated air flow (l/s)	H	97	142	189	236	283	331	378	472	567	661
	M	74	103	144	179	207	256	271	351	449	494
	L	58	71	110	132	156	197	204	267	314	414
Cooling (kW)		2.1	2.95	3.95	4.8	5.7	6.5	7.5	9.2	10.8	12.6
Heating (kW)		3.35	4.8	6.9	8.05	9.2	9.9	12.05	15.1	17.2	20
Water flow (l/s)		0.1	0.14	0.19	0.23	0.27	0.31	0.37	0.44	0.52	0.61
Water resistance(kPa)		5	9	18	21	38	26	39	24	35	48
Noise (dBA)		35	36	39	41	43.5	45	44	46	48	50
Power Input (w)		31	46	62	75	94	123	126	150	189	228
Weight (kg)		16	18	20	22	24	28	34	38	45	53

Floor Exposed Type

(ML-2, ML-3)

1. Water outlet 3/4FPT
2. Water inlet 3/4FPT
3. Drain conn 3/4FPT
4. Filter
5. Terminal box
6. Switch

Note:

1. M – motor quantity
2. F – fan quantity

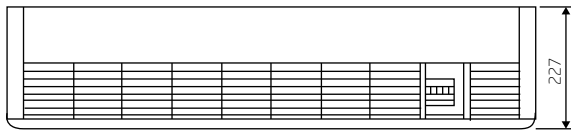
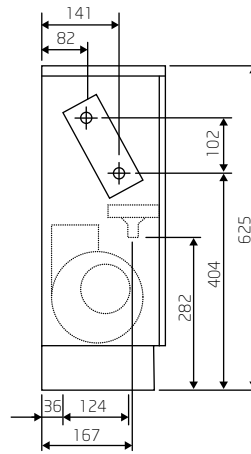
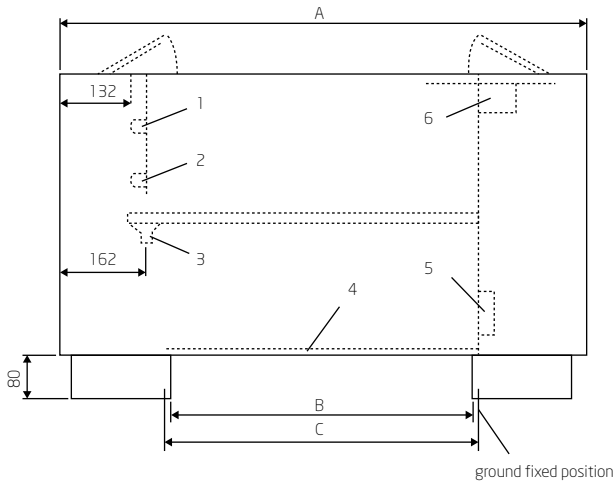
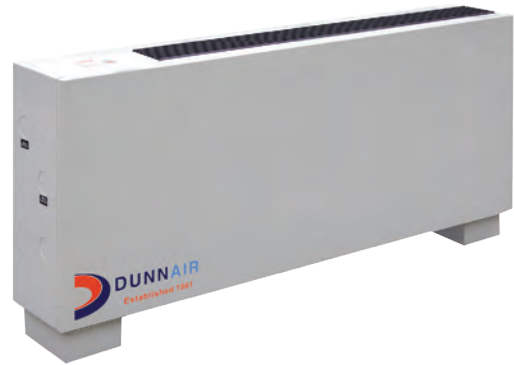

Dimension

Model	20-2 20-3	30-2 30-3	40-2 40-3	50-2 50-3	60-2 60-3	70-2 70-3	80-2 80-3	100-2 100-3	140-2 140-3
A	1006	1101	1196	1291	1386	1481	1671	1671	2146
B	560	655	750	845	940	1063	1225	1225	1700
C	580	675	770	865	960	1055	1245	1245	1720
M	1	1	1	1	1	2	2	2	2
F	1	2	2	2	2	3	3	3	4

Floor Exposed FCU

FCU-ML-2 (2 rows 2 pipe system)

Model		20	30	40	50	60	70	80	100	120	140
Rated air flow (l/s)	H	94	142	189	236	283	331	378	472	567	661
	M	74	103	144	179	207	256	271	351	449	494
	L	58	74	110	132	156	197	204	267	314	414
Cooling (kW)	H	1.8	2.7	3.6	4.4	5.5	6.2	7.1	8.8	10.3	12.0
Heating (kW)	H	2.7	4.0	5.3	6.7	8.2	9.2	10.7	13.0	15.4	18.0
Water flow (l/s)	H	0.08	0.13	0.17	0.21	0.26	0.29	0.34	0.42	0.49	0.57
Water resistance (kPa)	H	4	8	17	21	37	25	39	24	33	48
Noise (dBA)	H	35	36	39	41	43.5	45	44	46	48	50
Power input (w)	H	31	46	62	75	94	123	126	150	186	228
Weight (kg)		20	22.9	24.8	25.7	28.6	33.5	38.2	41.9	49.5	59

FCU-ML-3 (3 rows 2 pipe system)

Model		20	30	40	50	60	70	80	100	120	140
Rated air flow (l/s)	H	94	142	189	236	283	331	378	472	567	661
	M	74	103	144	179	207	256	271	351	449	494
	L	58	74	110	132	156	197	204	267	314	414
Cooling (kW)	H	2.1	2.95	4.0	4.8	5.7	6.5	7.5	9.2	10.8	12.6
Heating (kW)	H	3.4	4.8	6.8	8.1	9.2	9.9	12.1	15.1	17.2	20.0
Water flow (l/s)	H	0.1	0.14	0.19	0.23	0.27	0.31	0.37	0.44	0.52	0.61
Water resistance (kPa)	H	5	9	18	21	38	26	39	24	35	48
Noise (dBA)	H	35	36	39	41	43.5	45	44	46	48	50
Power input (w)	H	31	46	62	75	94	123	126	150	189	228
Weight (kg)		21	24	26	28	30	35	40	44	52	60

Note:

- Nominal condition is based on Australian standard/T19232-2003. Cooling: DB 27°C, WB 19.5°C
Chilled water inlet temp 7°C water temp rise 5°C
Heating: DB 21°C chilled water inlet temp 60°C
Water flow rate is the same as cooling
- Standard working pressure of fan coil is 1.8 Mpa, if working pressure is over 1.8 Mpa, please indicate when ordering.

Ceiling Exposed Type

(CE-2, CE-3)

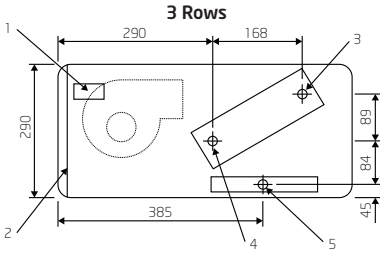
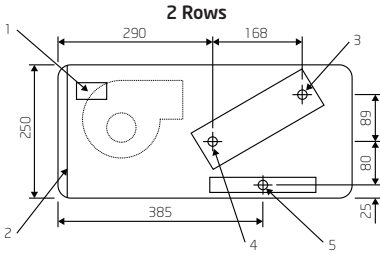
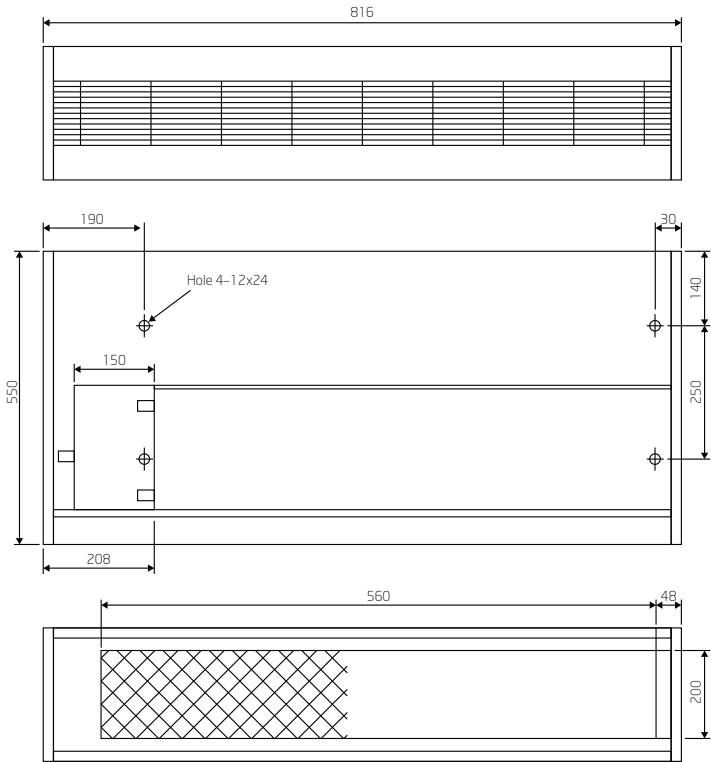

- 1. Junction Box
- 2. Filter Screen
- 3. Water Outlet 3/4 FPT
- 4. Water Inlet 3/4 FPT
- 5. Drain Connection 3/4 FPT



Dimension

Model	FCU-20CE	FCU-30CE	FCU-40CE	FCU-60CE	FCU-80CE	FCU-100CE	FCU-120CE
A	816	911	1006	1196	1487	1671	1956
B	550	655	750	940	1225	1415	1700

Ceiling Exposed FCU

FCU-CE-2 (2 rows 2 pipe system)

Model		20	30	40	60	80	100	120
Rated air flow (l/s)	H	108	153	200	283	378	472	567
	M	81	114	150	211	283	354	425
	L	69	92	119	156	225	260	311
Cooling (kW)		1.85	2.5	3.45	4.99	7.01	7.8	9.83
Heating (kW)		2.94	4.18	5.51	7.94	10.88	12.82	15.77
Water flow (l/s)		0.09	0.13	0.16	0.24	0.34	0.37	0.47
Water resistance(kPa)		2.5	5.4	10.1	24.3	6	10.7	19.9
Noise (dBA)		37	35	38	46	42	47	48
Power Input (w)		35	43	48	97	136	185	193
Weight (kg)		28	30	35	41	53	58	62

FCU-CE-3 (3 rows 2 pipe system)

Model		20	30	40	60	80	100	120
Rated air flow (l/s)	H	103	147	189	264	347	444	542
	M	78	111	144	200	264	336	411
	L	67	89	117	150	217	252	306
Cooling (kW)		2.56	3.57	4.55	6.38	8.63	10.39	12.88
Heating (kW)		3.65	5.17	6.6	9.23	12.33	15.26	18.72
Water flow (l/s)		0.12	0.17	0.22	0.3	0.41	0.5	0.62
Water resistance(kPa)		6.9	15.4	2.3	7	16.1	28.4	48.9
Noise (dBA)		37	35	38	46	42	47	48
Power Input (w)		35	43	48	97	136	185	193
Weight (kg)		30	32	38	45	58	65	69

Notes for Return Air:

1. Cooling: Air on temp. DB/WB 27°C/19.5°C Water in/out temp. 7°C/12°C
2. Heating: Air on temp. DB 21°C. Water in temp. 60°C.

Ceiling Cassette

Dimension for FCU XD-A 20, 30, 40

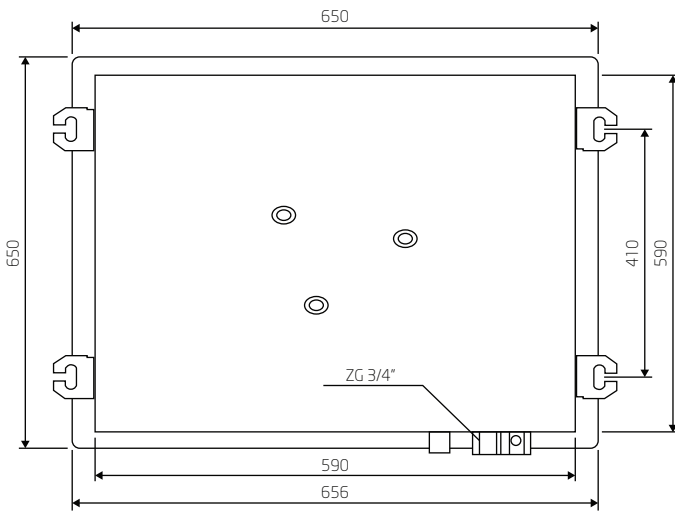
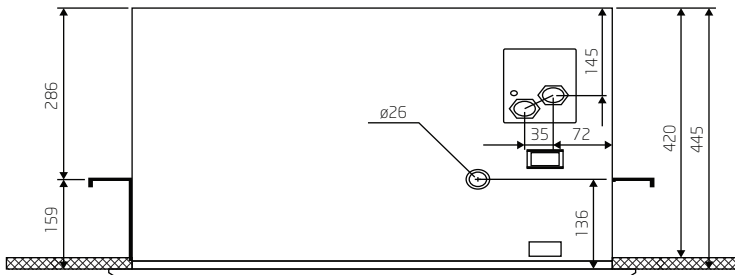

FCU-XD-2 (2 rows 2 pipe system)

Model		20	30	40	50	60	70	80	100	120
Rated air flow (l/s)	H	94	142	189	236	283	331	378	472	567
	M	74	103	144	179	207	256	271	351	449
	L	58	74	110	132	156	197	204	267	314
Cooling (kW)		1.77	2.65	3.55	4.42	5.45	6.16	7.1	8.75	10.26
Heating (kW)		2.66	3.98	5.32	6.72	8.18	9.19	10.65	12.97	15.39
Water flow (l/s)		0.08	0.13	0.17	0.21	0.26	0.29	0.34	0.42	0.49
Water resistance(kPa)		4	8	17	21	37	25	39	24	33
Noise (dBA)		35	36	39	41	43.5	45	44	46	48
Power Input (w)		31	46	62	75	94	123	126	150	189
Weight (kg)		31	34	37	40	42.5	50	51	59	67

Ceiling Cassette

Dimension for FCU XD-A 50 - 120

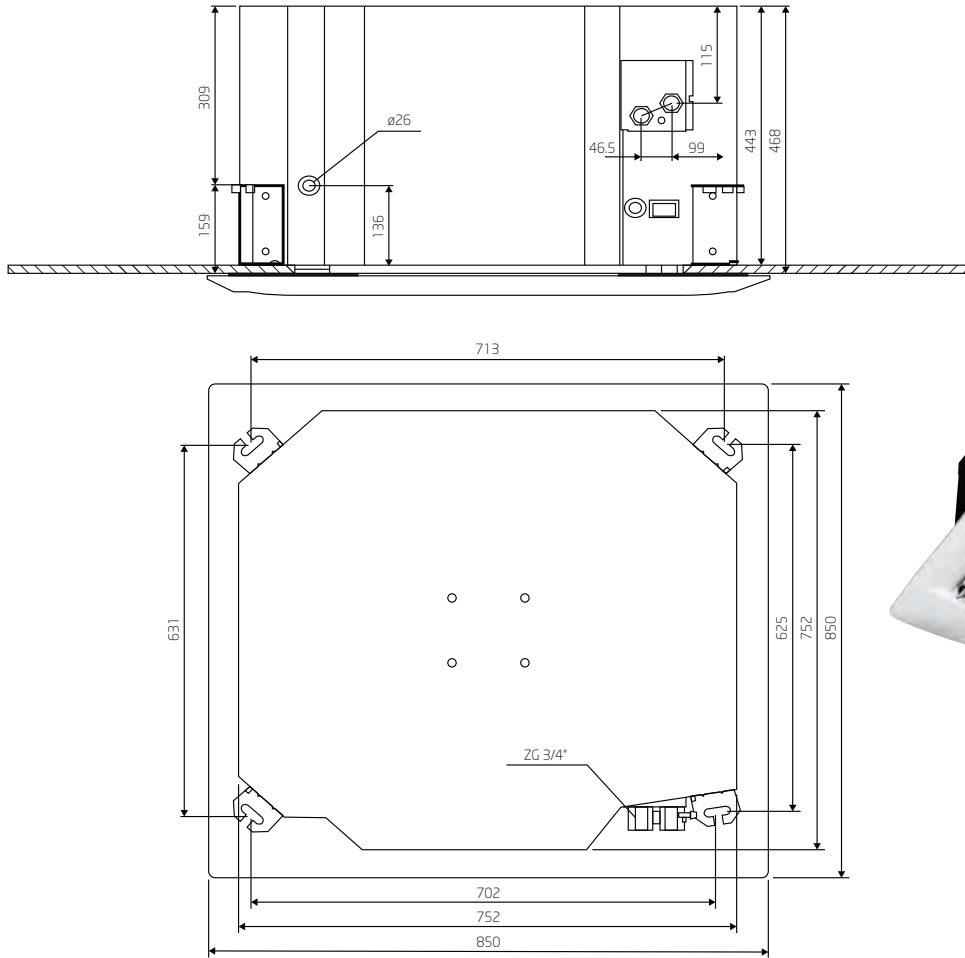

FCU-XD-3 (3 rows 2 pipe system)

Model		20	30	40	50	60	70	80	100	120
Rated air flow (l/s)	H	94	142	189	236	293	331	378	472	567
	M	74	103	144	179	207	256	271	351	449
	L	58	74	110	132	156	197	204	267	314
Cooling (kW)		2.1	2.95	3.95	4.8	5.7	6.5	7.5	9.2	10.8
Heating (kW)		3.35	4.8	6.8	8.05	9.2	9.9	12.05	15.1	17.2
Water flow (l/s)		0.1	0.14	0.19	0.23	0.27	0.31	0.37	0.44	0.52
Water resistance(kPa)		5	9	18	21	38	26	39	24	35
Noise (dBA)		35	36	39	41	43.5	45	44	46	48
Power Input (w)		31	46	62	75	94	123	126	150	189
Weight (kg)		32	35	38	41	44	51	53	61	69

Note:

- Nominal condition is based on Australian standard/T19232-2003.
Cooling: Air entering DB 27°C, WB 19.5°C; Water entering 7°C, Water leaving 12°C
Heating: Air entering DB 21°C; Water entering 60°C, Water leaving 12°C
Water flow rate is the same as cooling
- Standard working pressure of fan coil is 1.8 Mpa, If the working pressure is over 1.8 Mpa, please indicate when ordering.

Wiring Diagram

Five speed type

If the air inlet temp beyond this condition: return air temp. DB 27°C, 19.5°C (cooling), return air temp. DB 21°C (heating). Please use the following correction factor.

AL, AW, XD, CE, ML

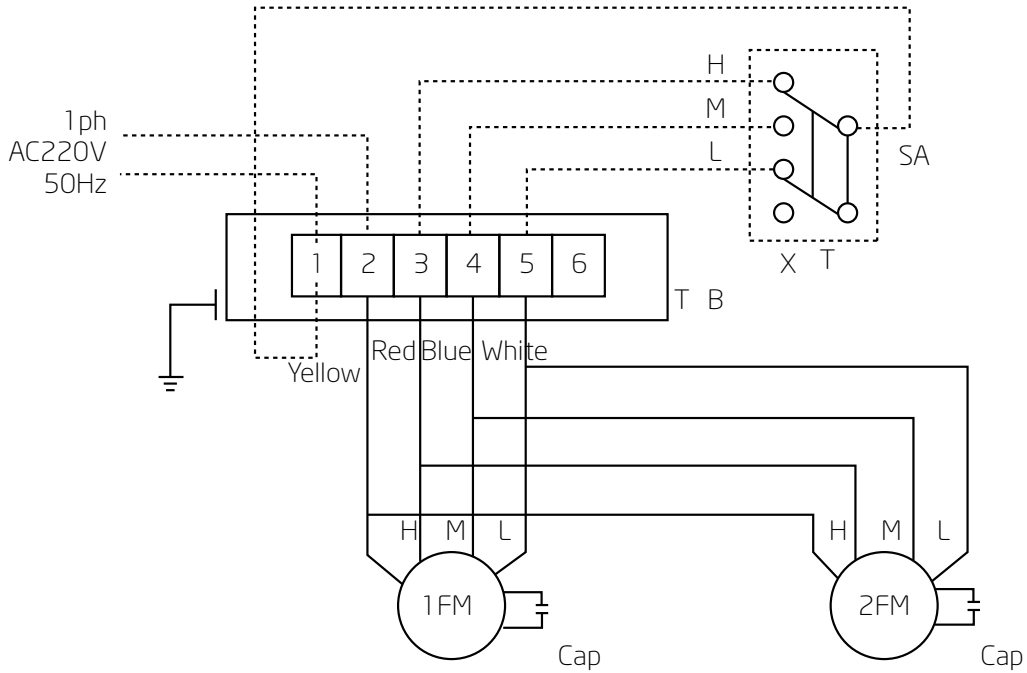

FCU - DF

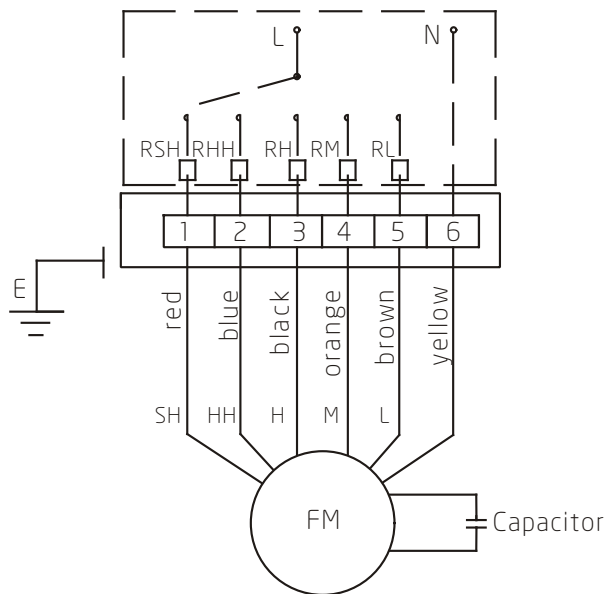

Model 30-160

Wiring Diagram

FCU - DF

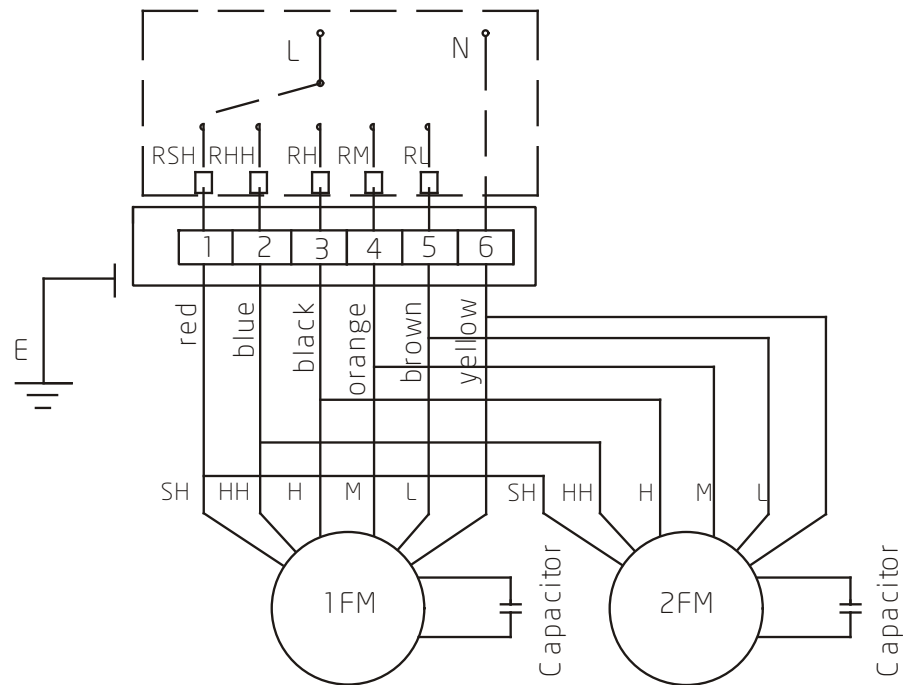

Model 180-200

Installation and Instruction

1. Rotate the impeller before mounting to assure free movement.
2. Install valves to water in and out pipes for regulating water flow. Water pipes should be kept insulated.
3. The weight of air and water pipes that are connected to the unit should not be supported by the unit.
4. A drain line pitch with minimum slope of 0.005 is recommended.
5. Discharge all water after pressure testing. Especially if installation occurs in frost/icy winter conditions.
6. Open the air vent before using and then close the valve to expel air and assure water flow.
7. Clean the filter periodically.
8. Earthing point is provided on the unit and must be properly connected to building grounding system
9. The electrical and pipe connection methods should be according to the unit's drawing/specification, so it does not cause damage to the unit.

Large Capacity Fan Coil Units Fan Curves

(DF)

FCU-30

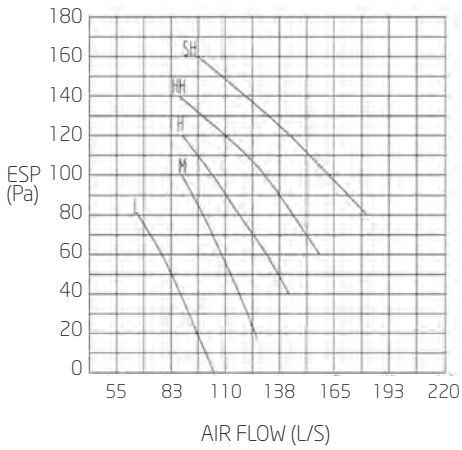

FCU-45

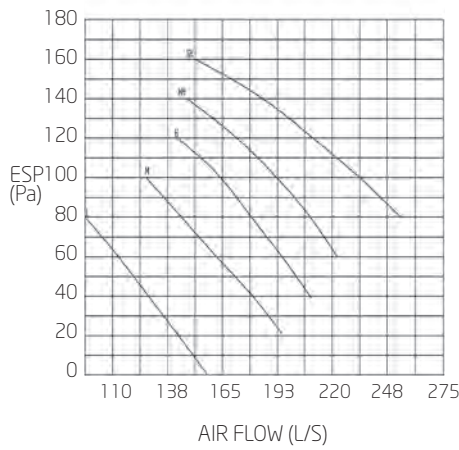

FCU-60

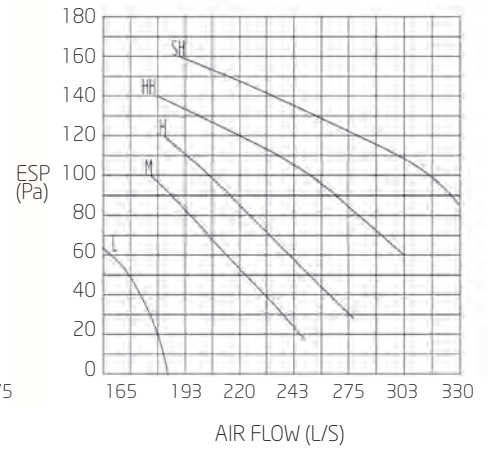

FCU-80

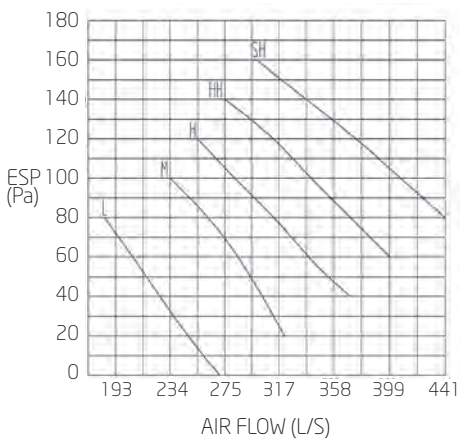

FCU-100

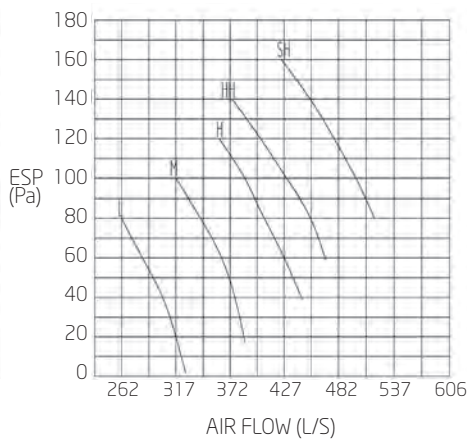

FCU-130

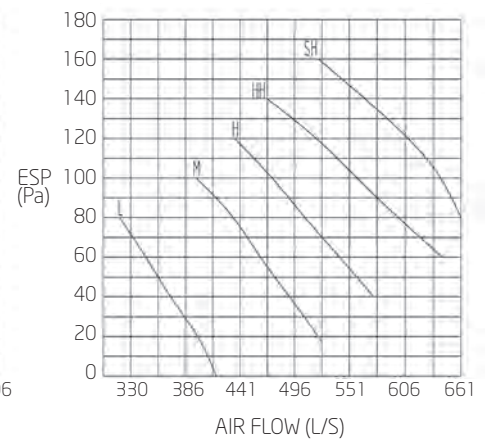

FCU-160

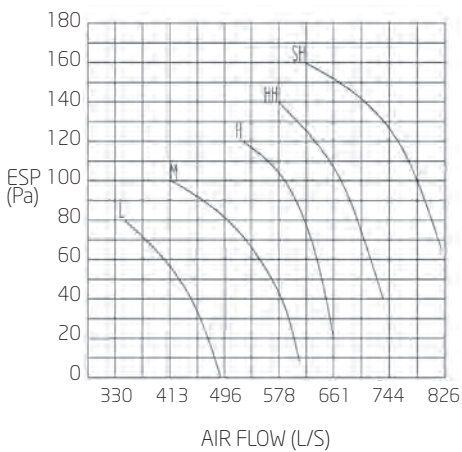

FCU-180

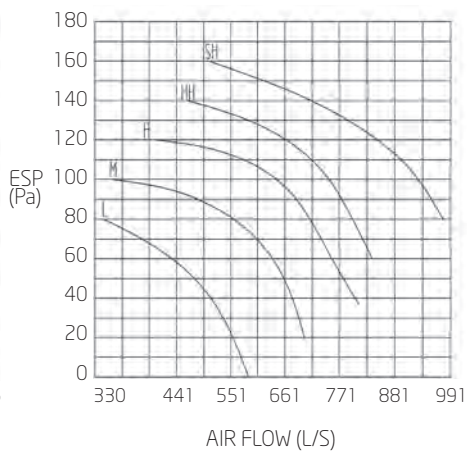

FCU-200

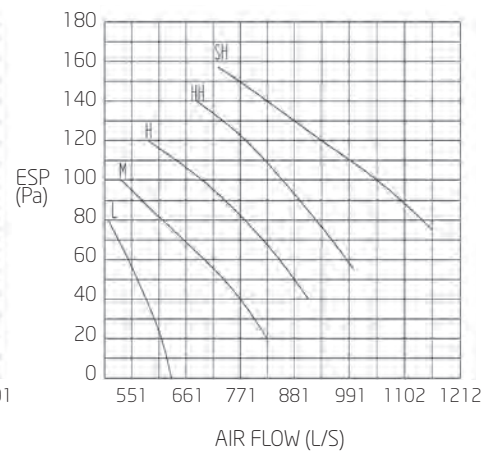

* note: The unit measure in a semi-anechoic environment, 1.0m from sound source.

FCU-240

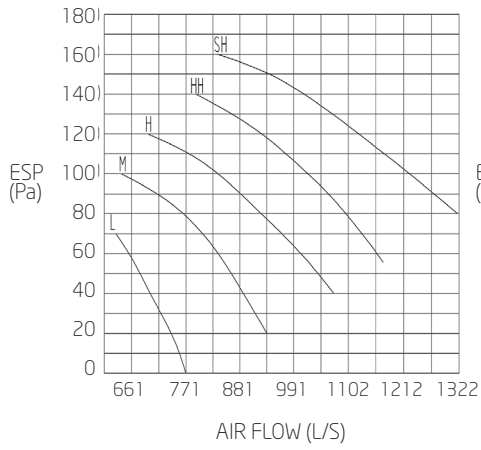

FCU-300

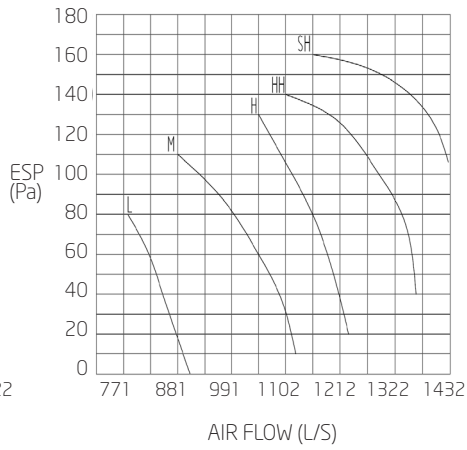

FCU-350

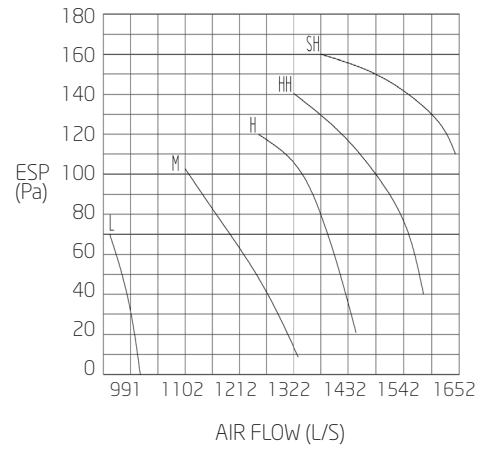

Large Capacity Fan Coil Units Noise Curves

(DF)

FCU-30

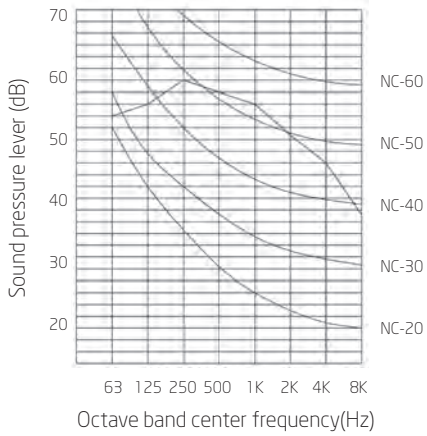

FCU-45

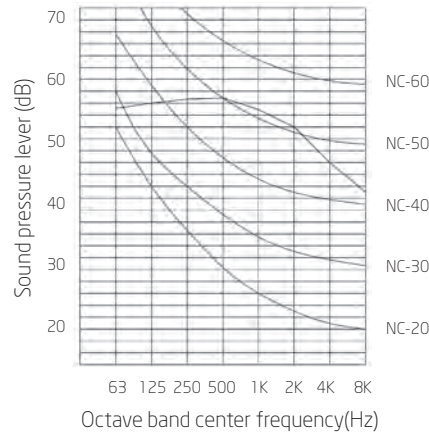

FCU-60

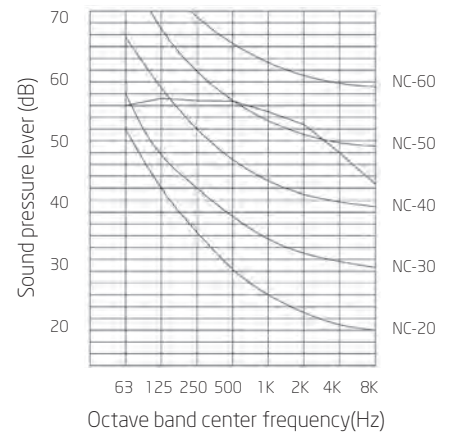

FCU-80

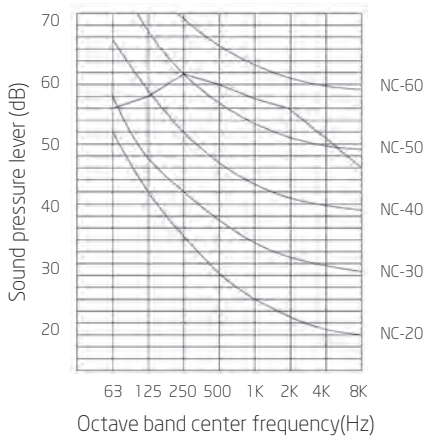

FCU-100

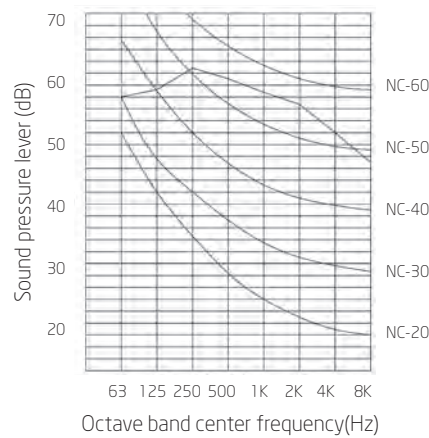

FCU-130

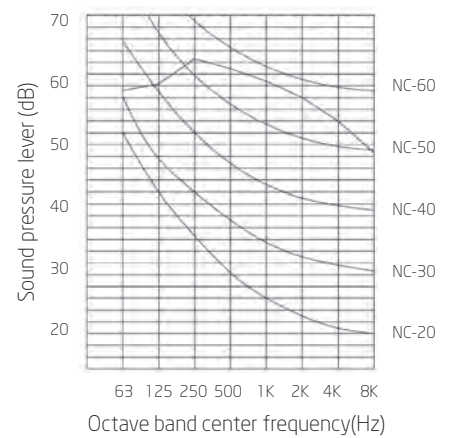

FCU-160

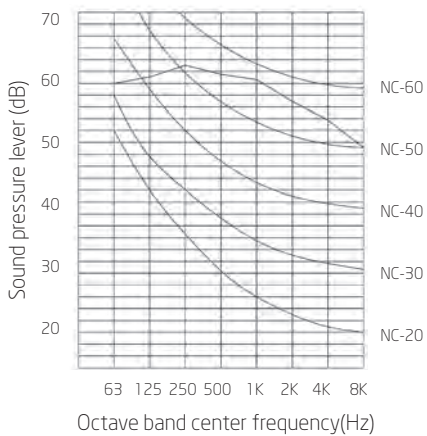

FCU-180

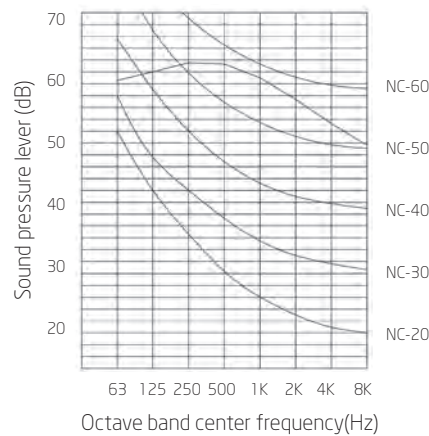

FCU-200

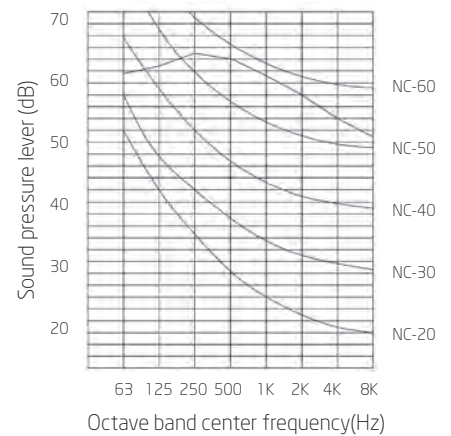

* note: The unit measure in a semi-anechoic environment, 1.0m from sound source.

FCU-240

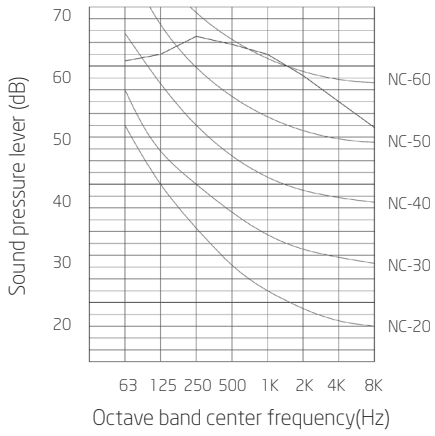

FCU-300

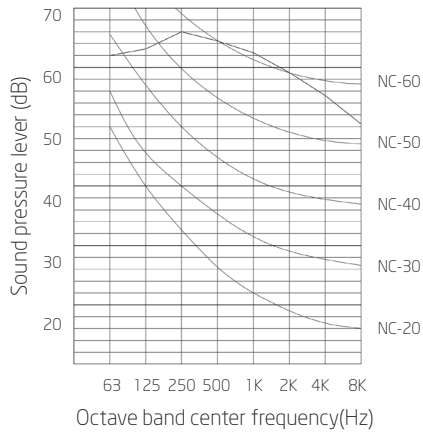

FCU-350

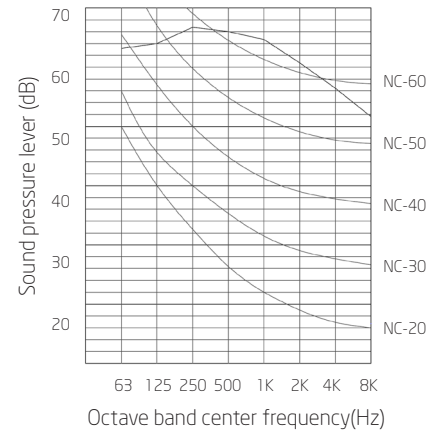

Ceiling Concealed Type Fan Curves

(AW-2, AWH-2, AW-3, AWH-3) Concealed 2 and 3 rows

FCU-20

Standard Type

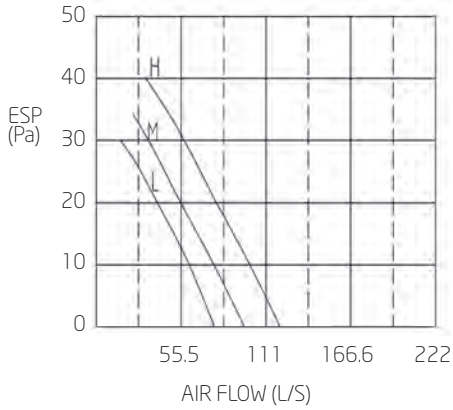

Medium Static Pressure Type

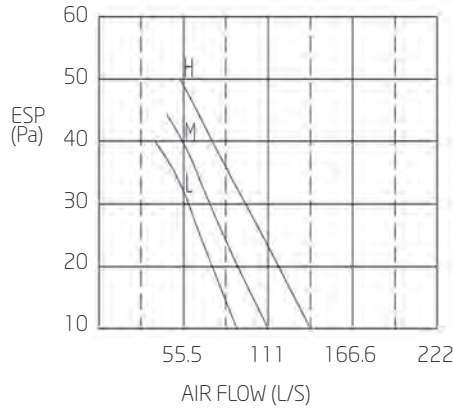

High Static Pressure Type

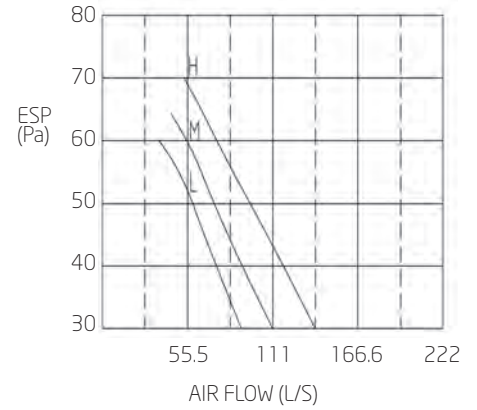

FCU-30

Standard Type

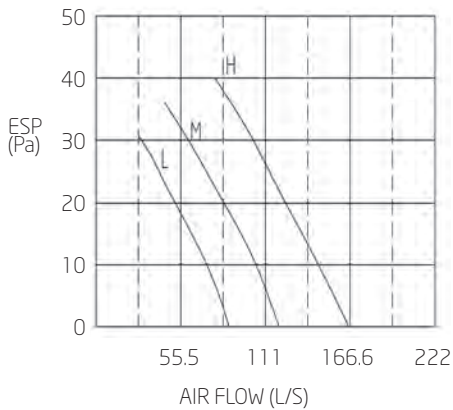

Medium Static Pressure Type

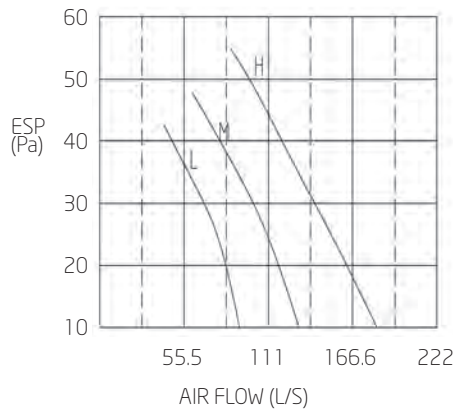

High Static Pressure Type

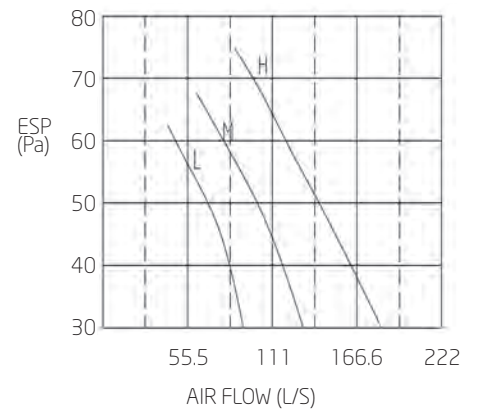

FCU-40

Standard Type

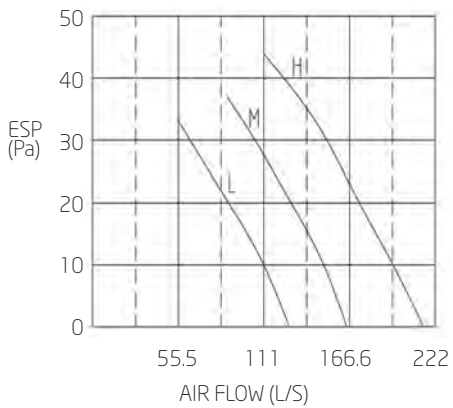

Medium Static Pressure Type

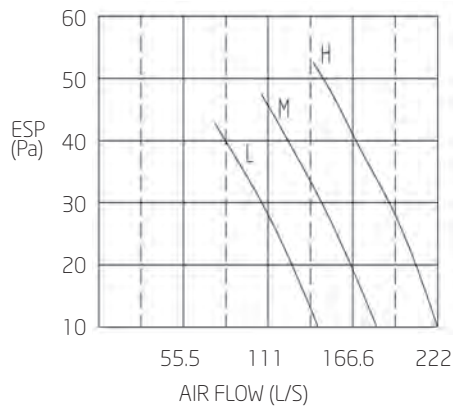

High Static Pressure Type

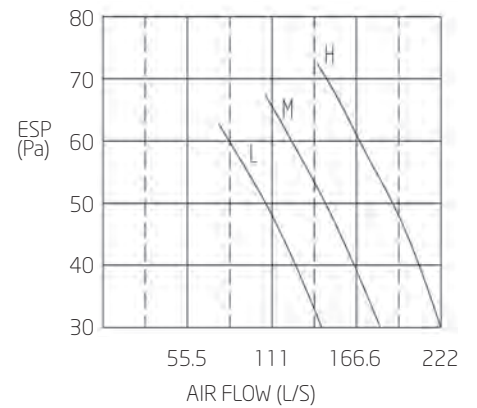

Ceiling Concealed Type Fan Curves

(AW-2, AWH-2, AW-3, AWH-3) Concealed 2 and 3 rows

FCU-50

Standard Type

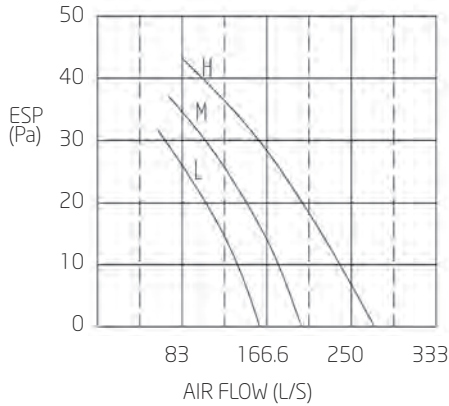

Medium Static Pressure Type

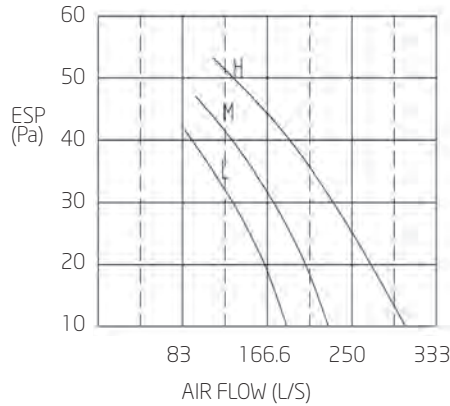

High Static Pressure Type

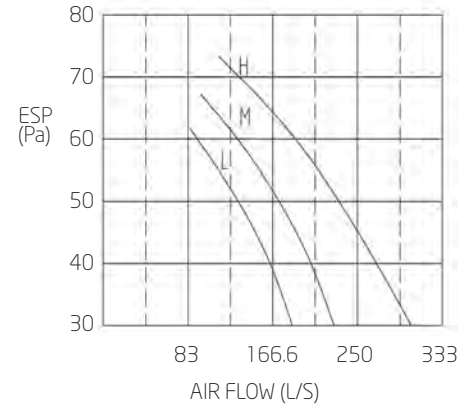

FCU-60

Standard Type

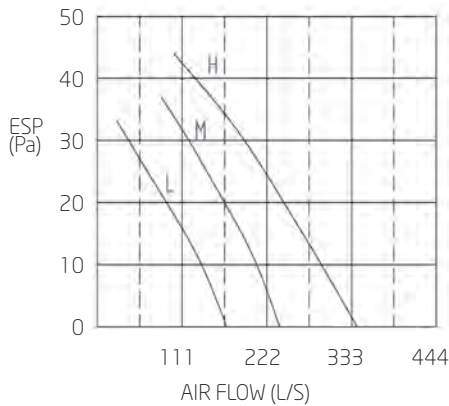

Medium Static Pressure Type

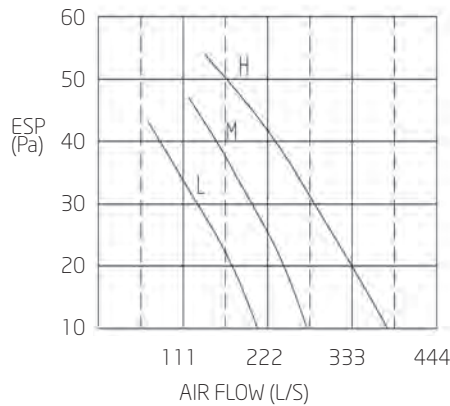

High Static Pressure Type

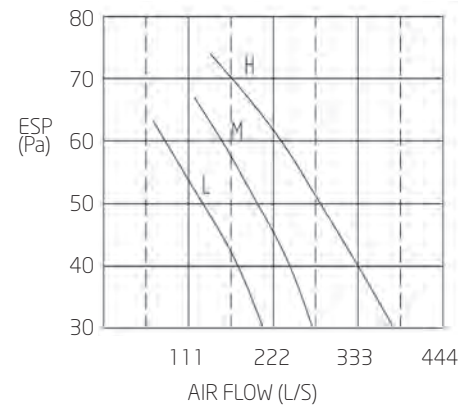

FCU-70

Standard Type

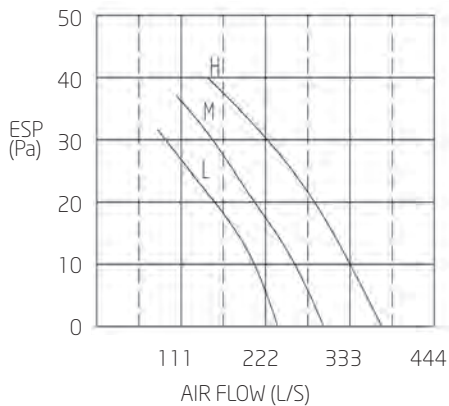

Medium Static Pressure Type

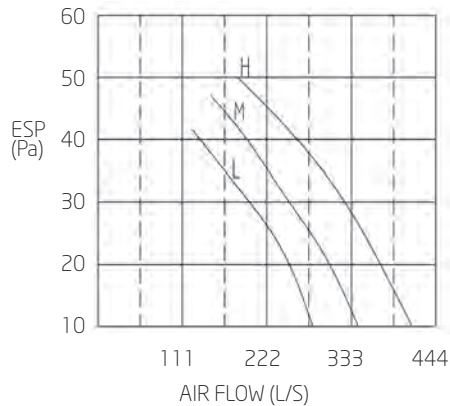

High Static Pressure Type

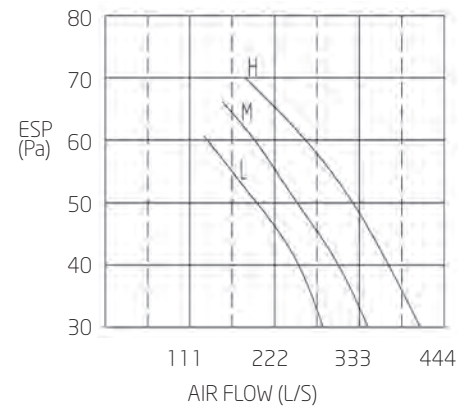

FCU-80

Standard Type

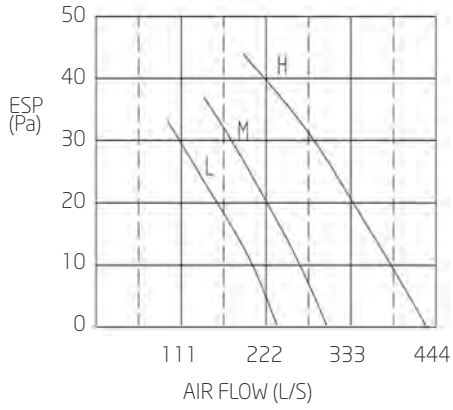

Medium Static Pressure Type

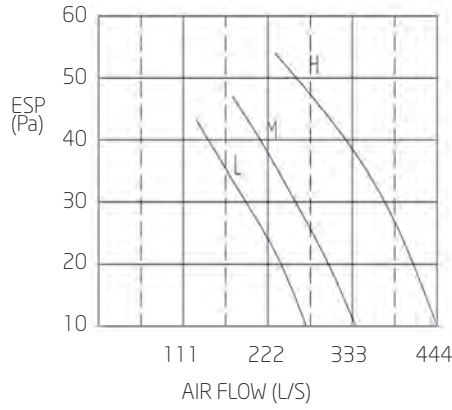

High Static Pressure Type

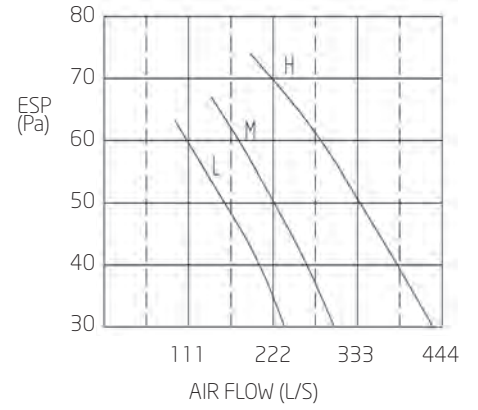

FCU-100

Standard Type

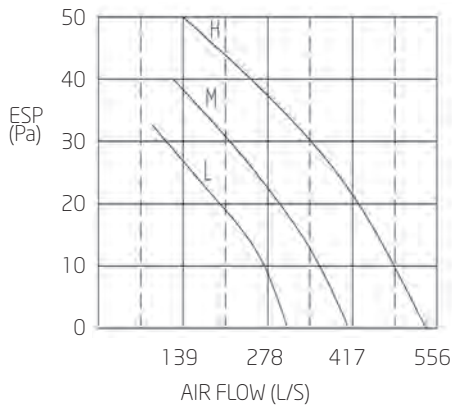

Medium Static Pressure Type

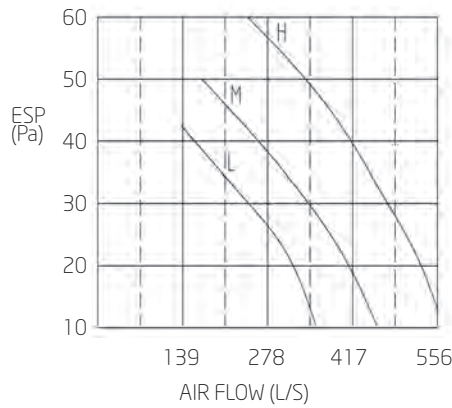

High Static Pressure Type

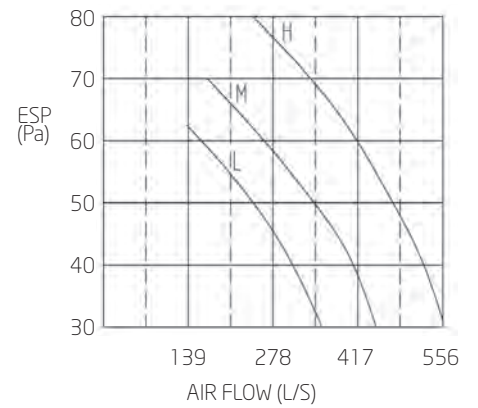

FCU-120

Standard Type

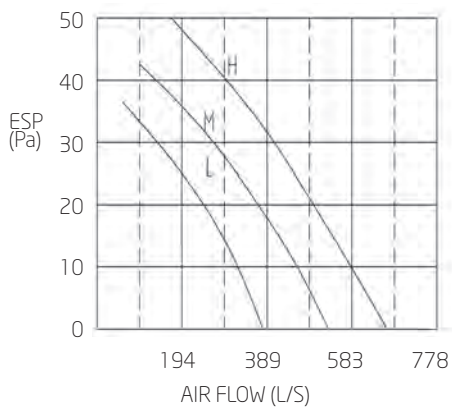

Medium Static Pressure Type

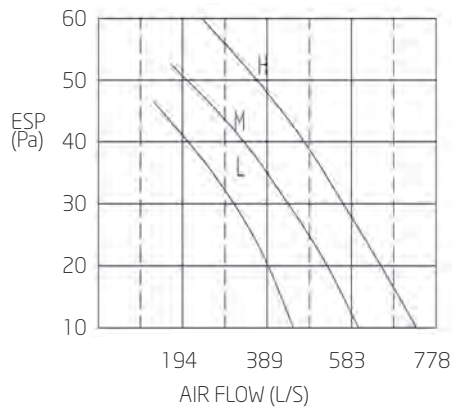

High Static Pressure Type

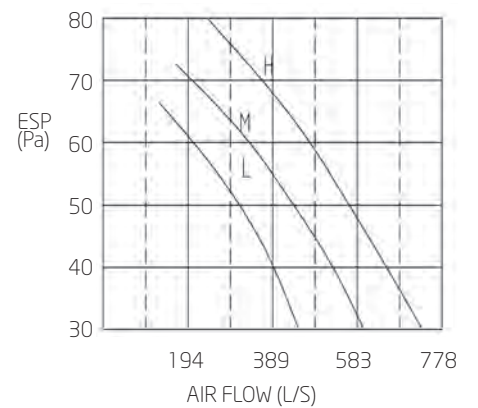

Ceiling Concealed Type Fan Curves

(AW-2, AWH-2, AW-3, AWH-3) Concealed 2 and 3 rows

FCU-140

Standard Type

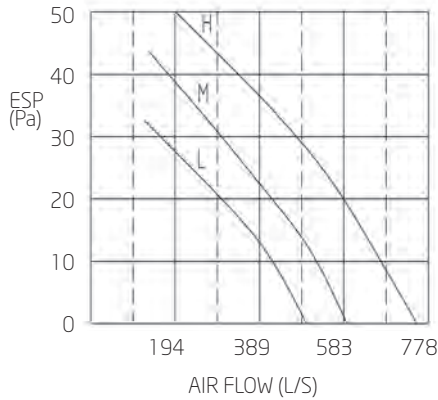

Medium Static Pressure Type

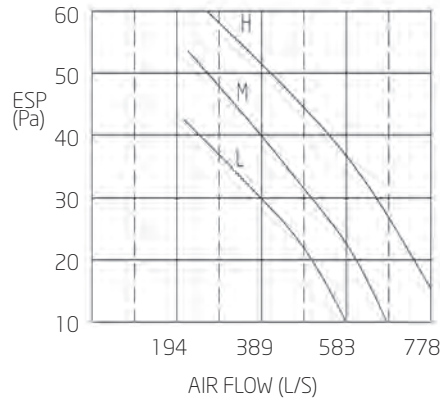

High Static Pressure Type

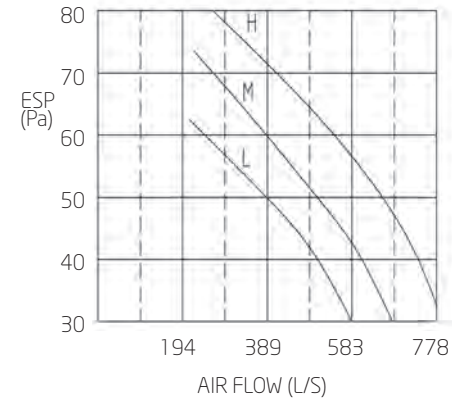

Ceiling Concealed Type Fan Curves

(AW-2, AWH-2, AW-3, AWH-3) 2+1 rows and 3+1 rows

FCU-20

Standard Type

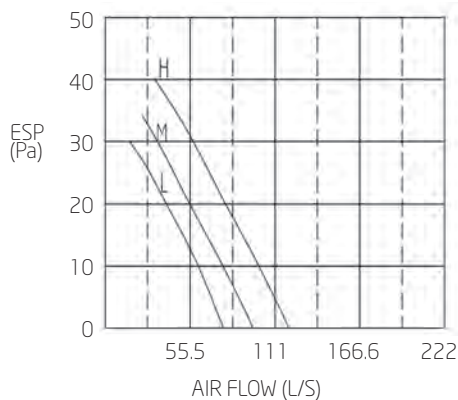

Medium Static Pressure Type

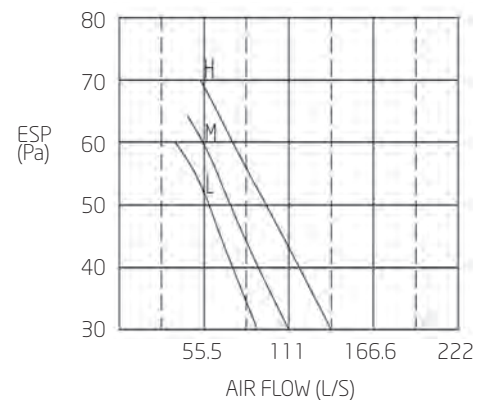

FCU-30

Standard Type

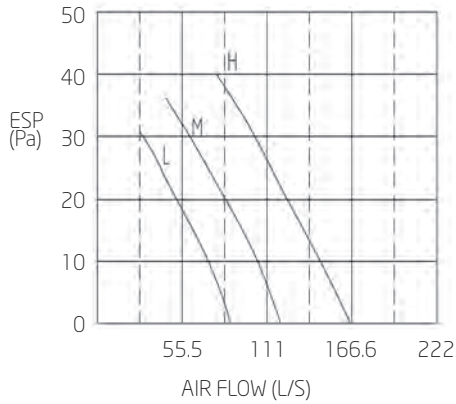

Medium Static Pressure Type

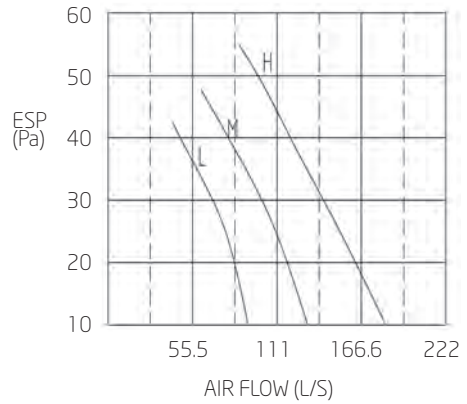

FCU-40

Standard Type

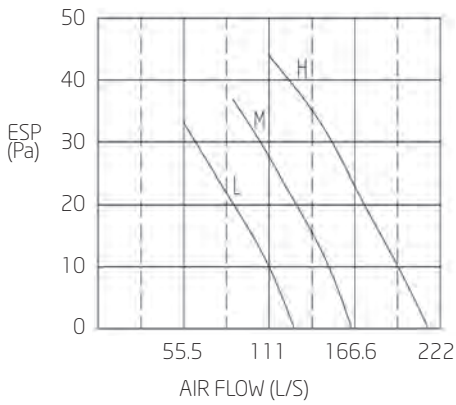

Medium Static Pressure Type

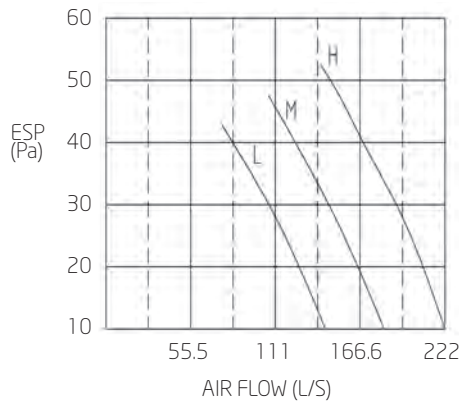

FCU-50

Standard Type

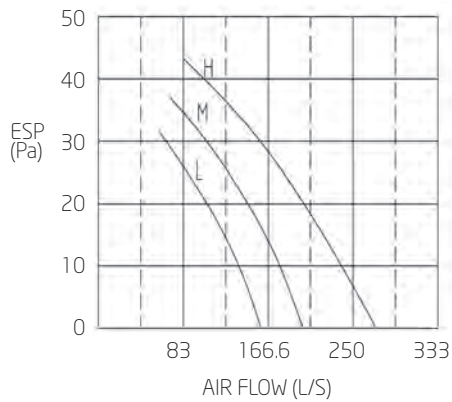

Medium Static Pressure Type

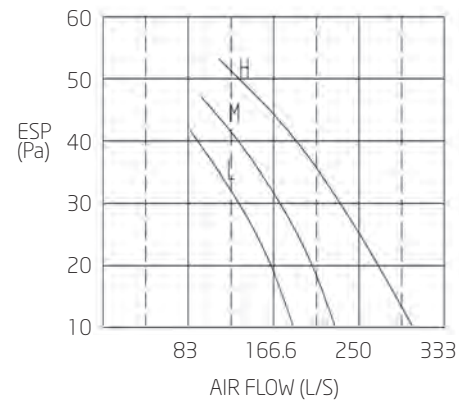

Ceiling Concealed Type Fan Curves

(AW-2, AWH-2, AW-3, AWH-3) 2+1 rows and 3+1 rows

FCU-60

Standard Type

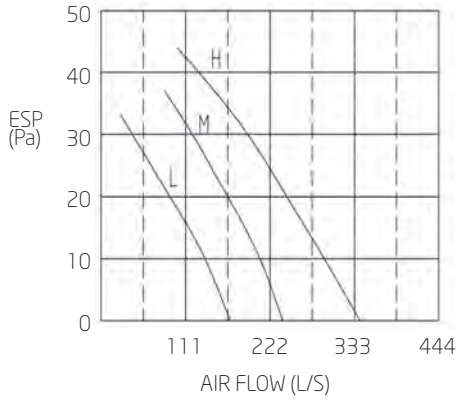

Medium Static Pressure Type

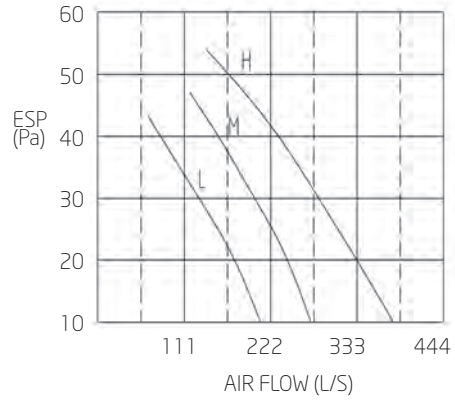

FCU-70

Standard Type

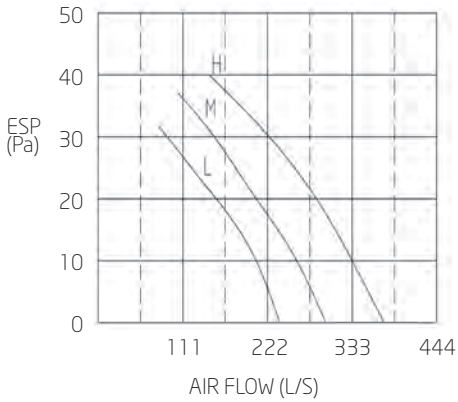

Medium Static Pressure Type

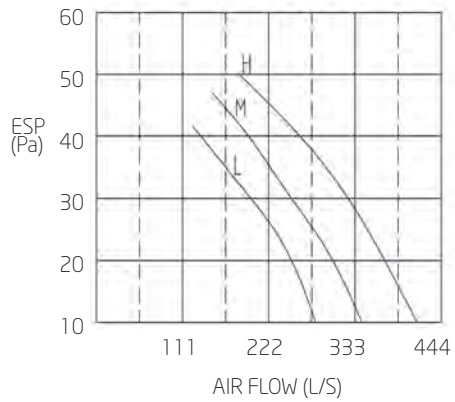

FCU-80

Standard Type

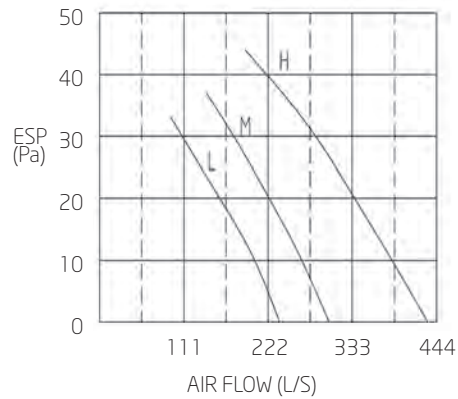

Medium Static Pressure Type

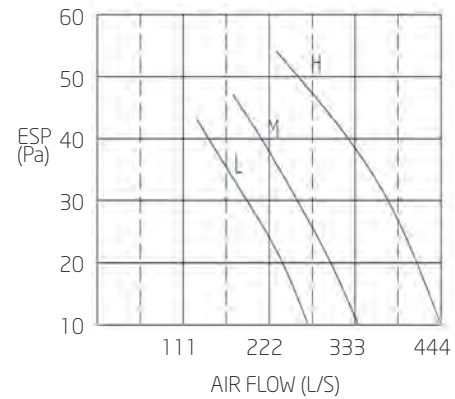

FCU-100

Standard Type

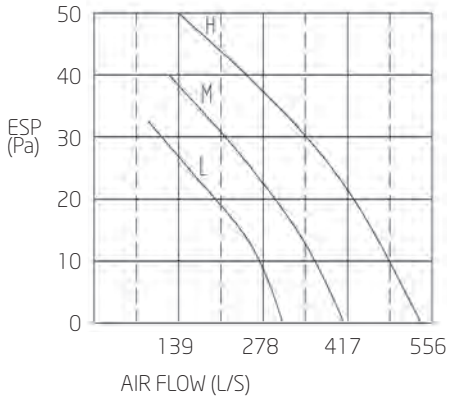

Medium Static Pressure Type

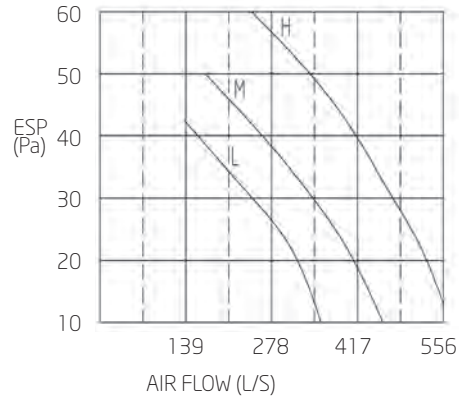

FCU-120

Standard Type

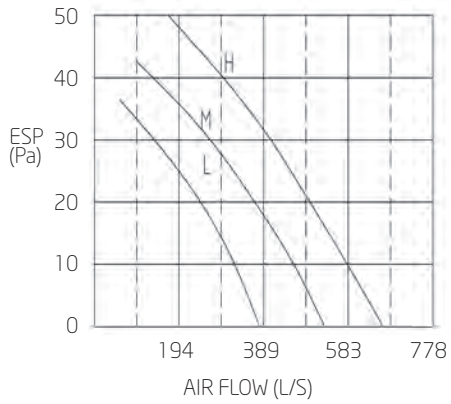

Medium Static Pressure Type

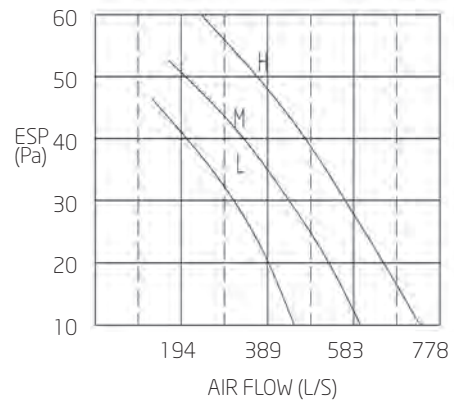

FCU-140

Standard Type

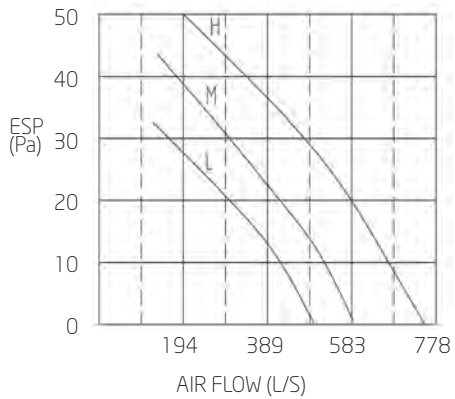

Medium Static Pressure Type

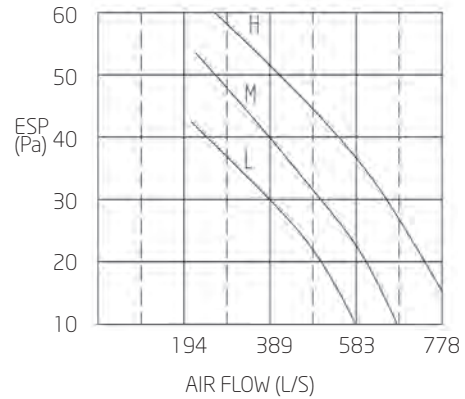

Ceiling Concealed Type Noise Curves

(AW-2, AWH-2, AW-3, AWH-3) Concealed 2 and 3 rows

FCU-20

Standard Type

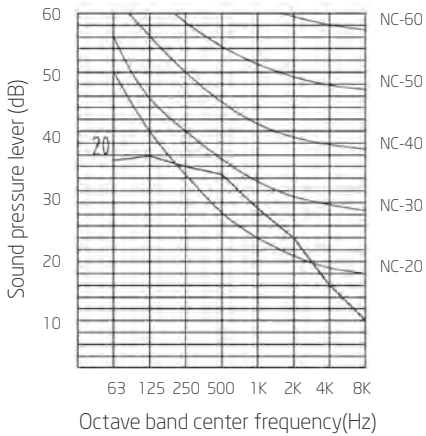

Medium Static Pressure Type

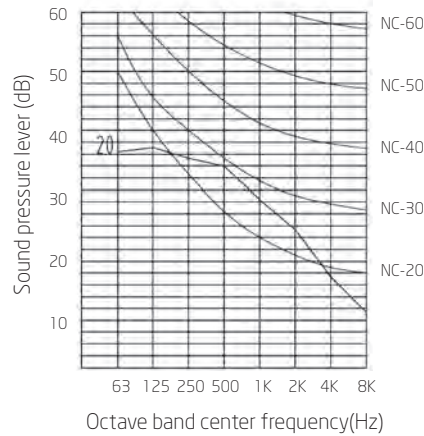

High Static Pressure Type

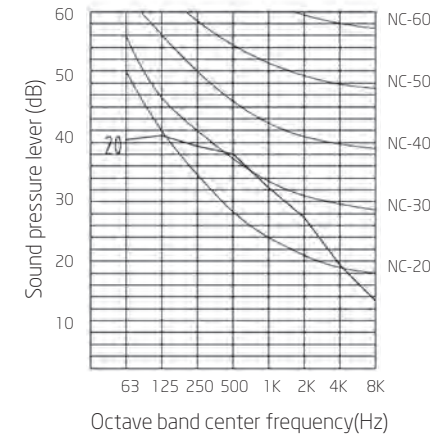

FCU-30

Standard Type

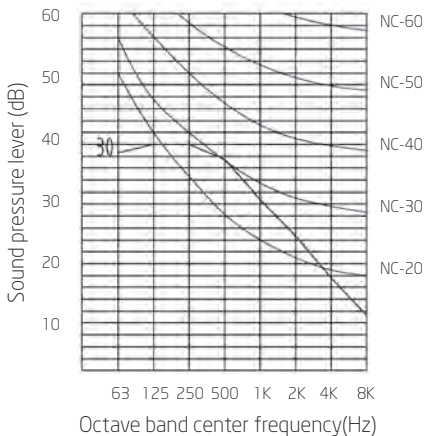

Medium Static Pressure Type

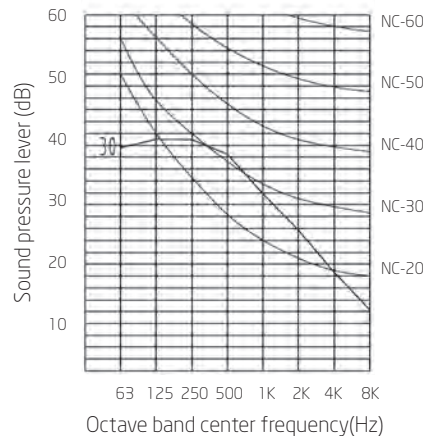

High Static Pressure Type

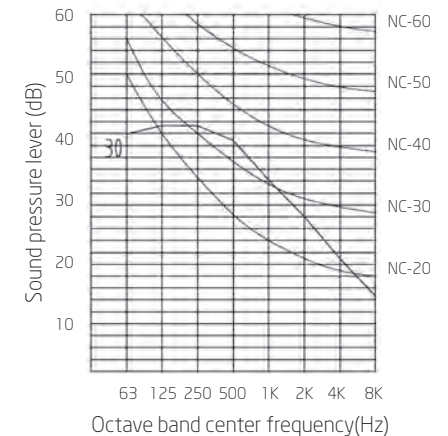

FCU-40

Standard Type

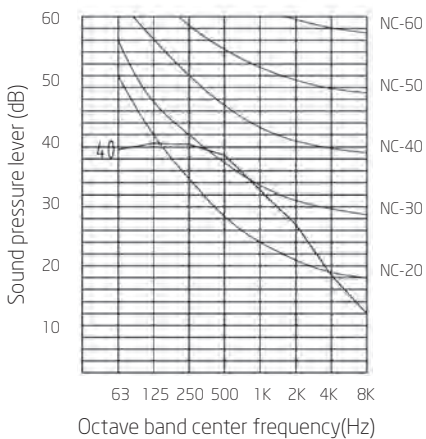

Medium Static Pressure Type

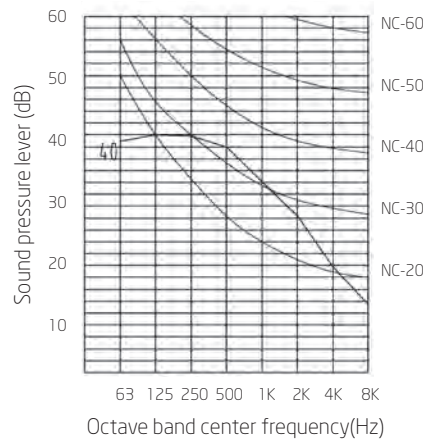

High Static Pressure Type

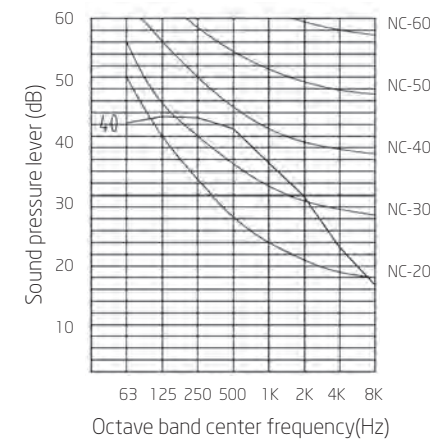

FCU-50

Standard Type

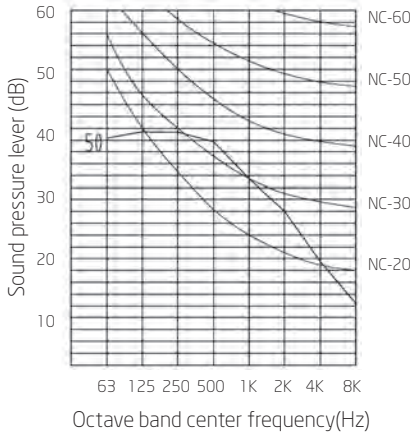

Medium Static Pressure Type

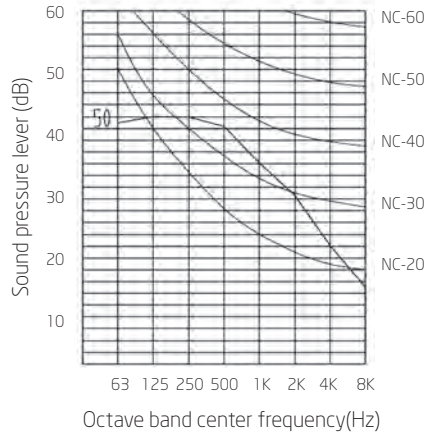

High Static Pressure Type

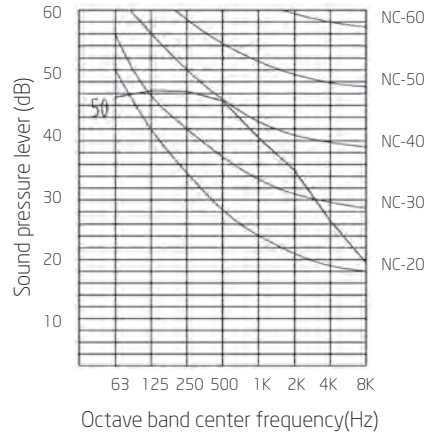

FCU-60

Standard Type

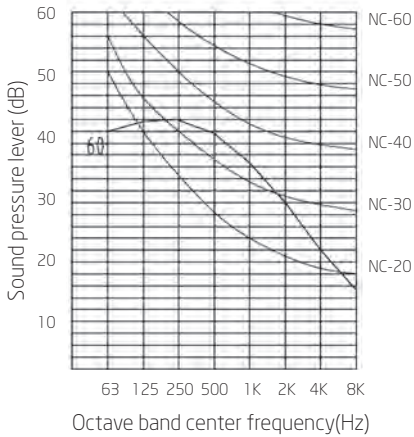

Medium Static Pressure Type

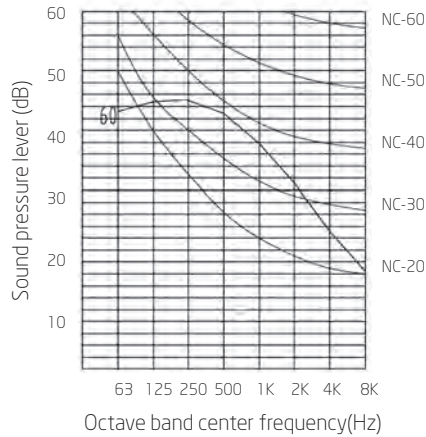

High Static Pressure Type

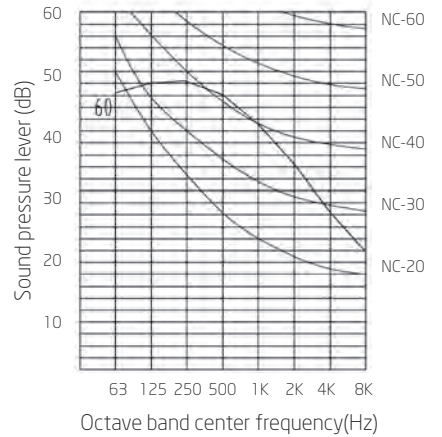

FCU-70

Standard Type

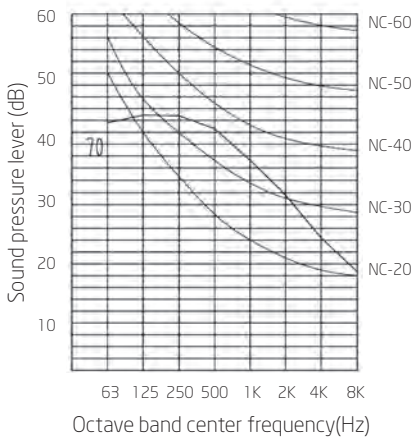

Medium Static Pressure Type

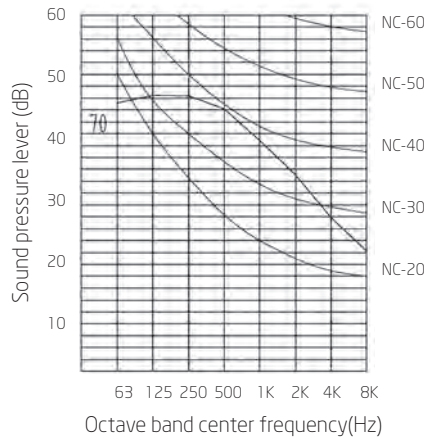

High Static Pressure Type

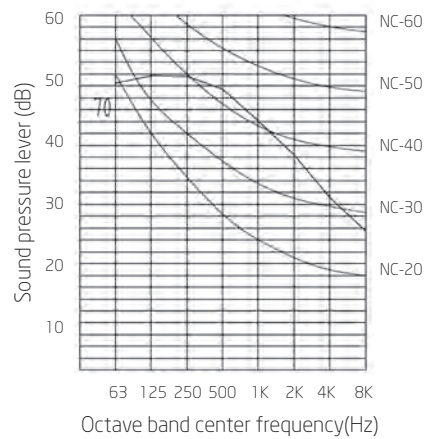

* note: The unit measure in a semi-anechoic environment, 1.0m from sound source.

Ceiling Concealed Type Noise Curves

(AW-2, AWH-2, AW-3, AWH-3) Concealed 2 and 3 rows

FCU-80

Standard Type

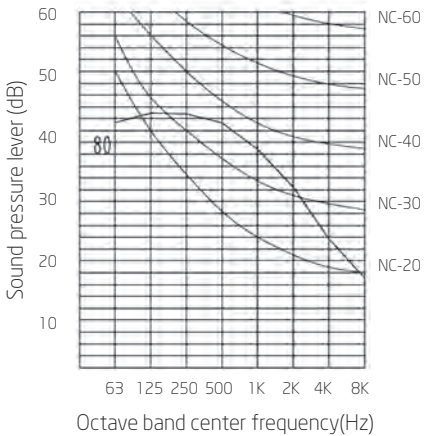

Medium Static Pressure Type

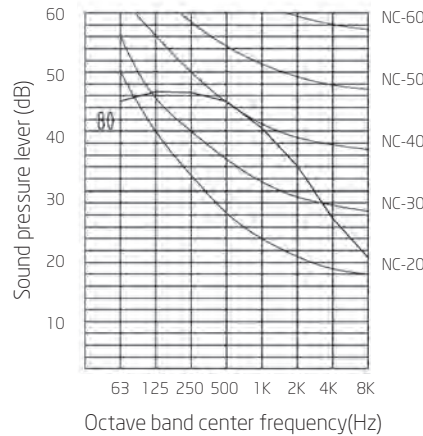

High Static Pressure Type

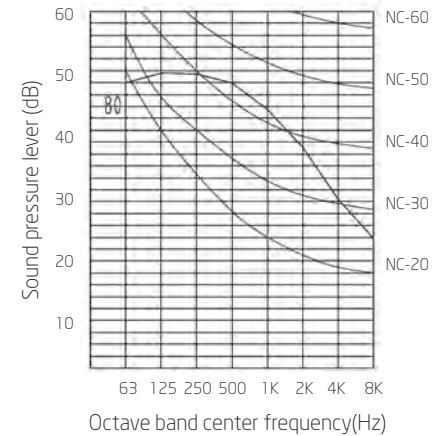

FCU-100

Standard Type

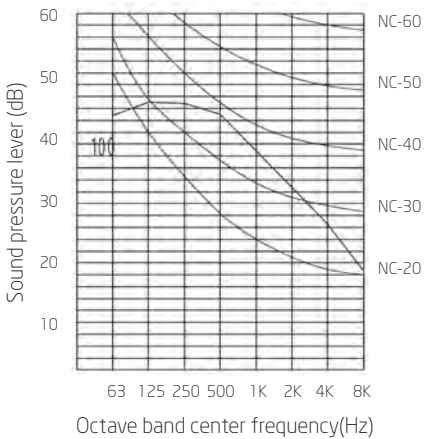

Medium Static Pressure Type

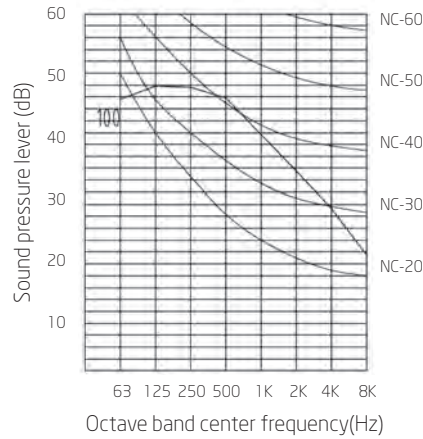

High Static Pressure Type

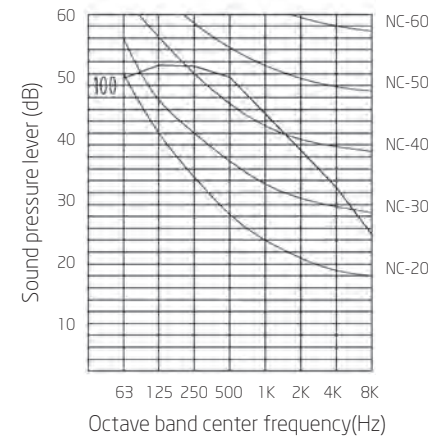

FCU-120

Standard Type

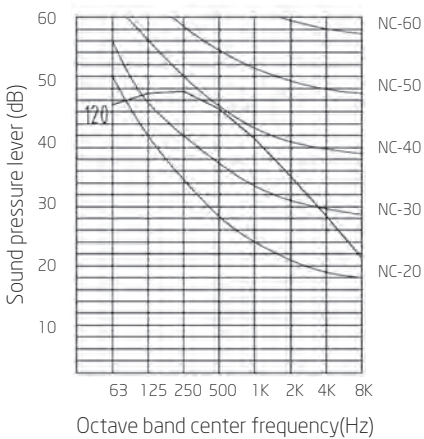

Medium Static Pressure Type

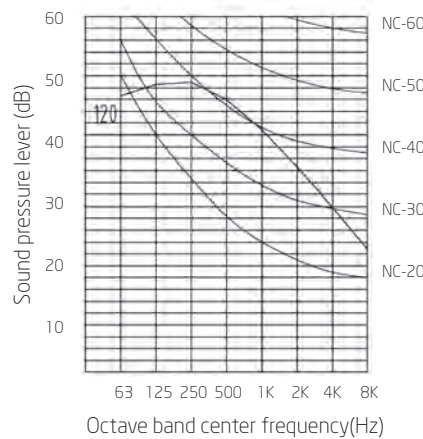

High Static Pressure Type

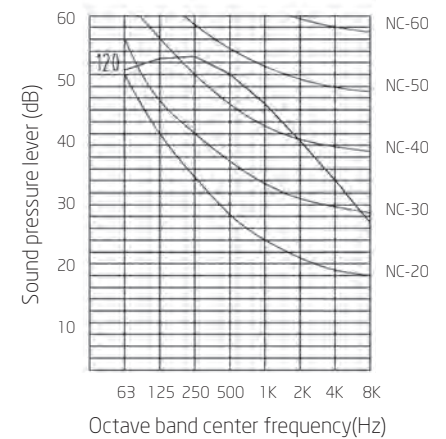

FCU-140

Standard Type

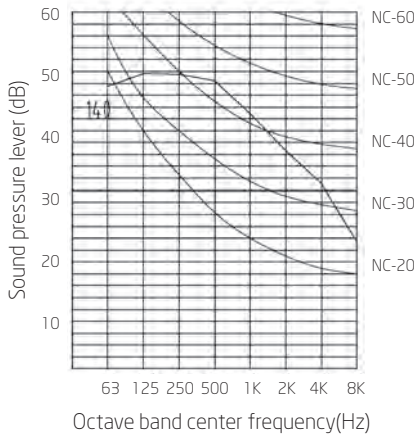

Medium Static Pressure Type

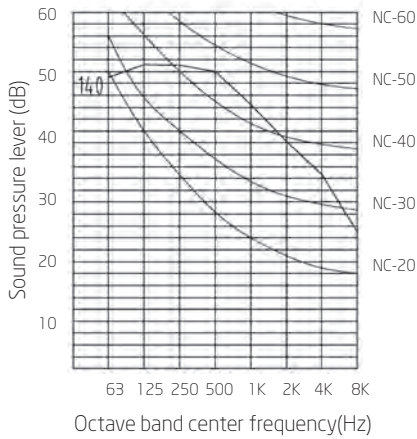

High Static Pressure Type

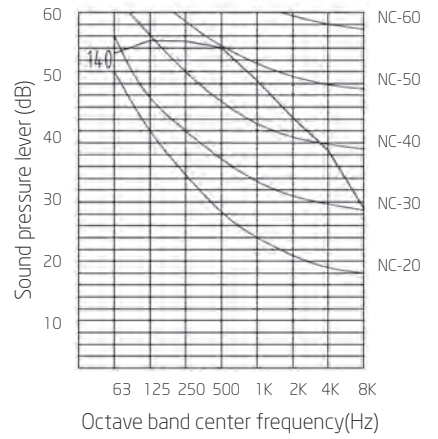

* note: The unit measure in a semi-anechoic environment, 1.0m from sound source.

Ceiling Concealed Type Noise Curves

(AW-2, AWH-2, AW-3, AWH-3) 2+1 rows and 3+1 rows

FCU-20

Standard Type

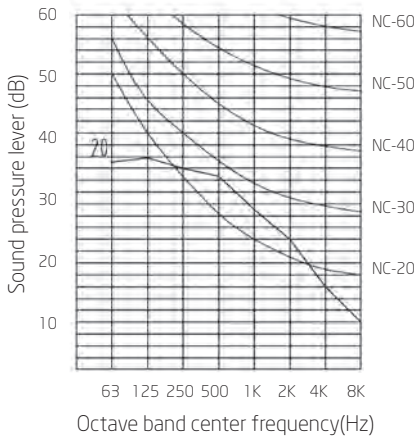

Medium Static Pressure Type

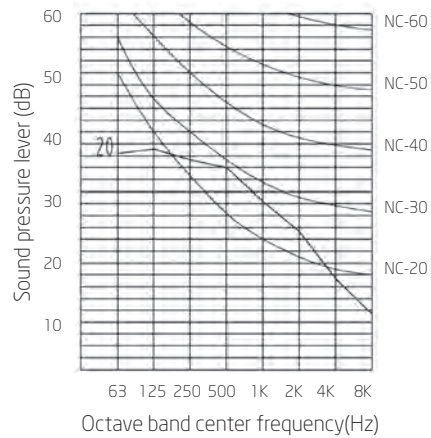

FCU-30

Standard Type

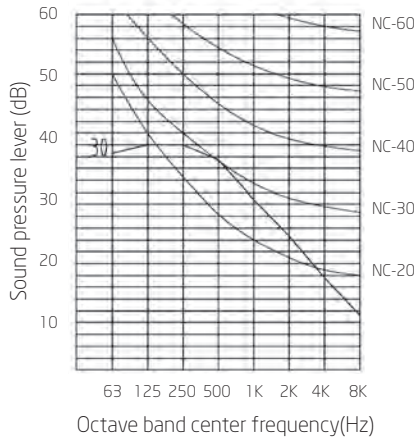

Medium Static Pressure Type

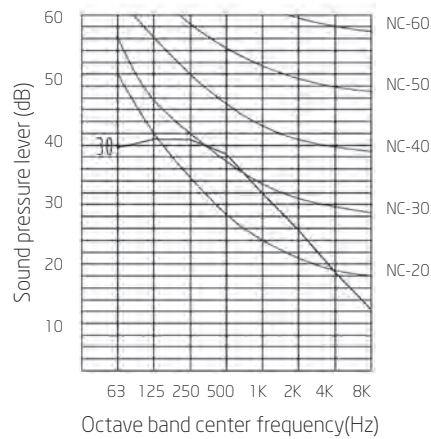

FCU-40

Standard Type

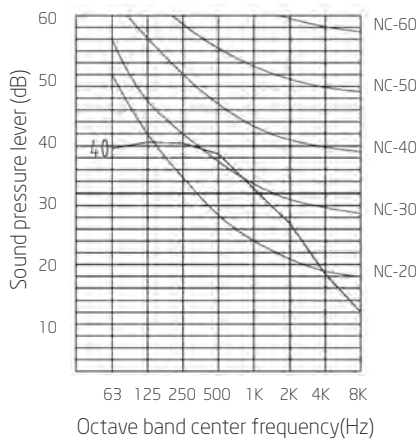

Medium Static Pressure Type

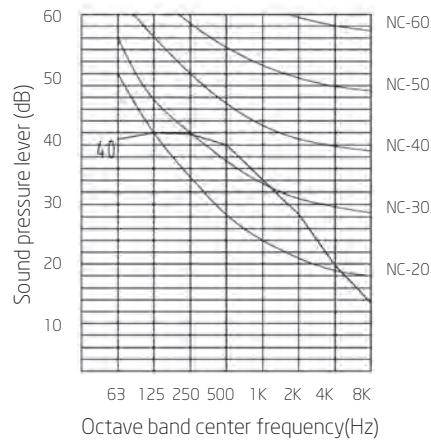

FCU-50

Standard Type

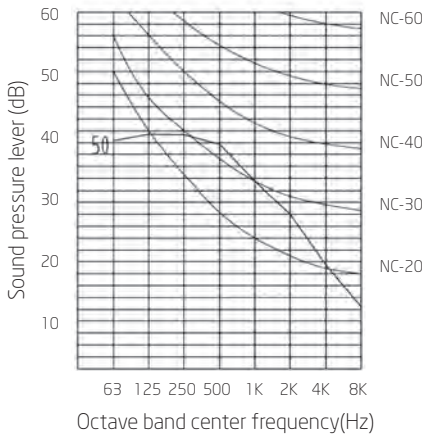

Medium Static Pressure Type

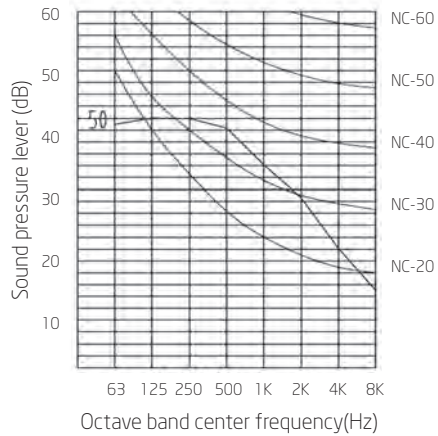

FCU-60

Standard Type

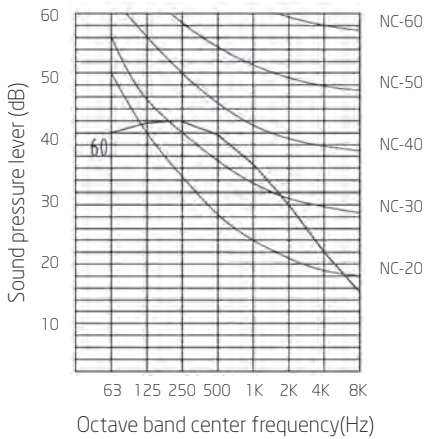

Medium Static Pressure Type

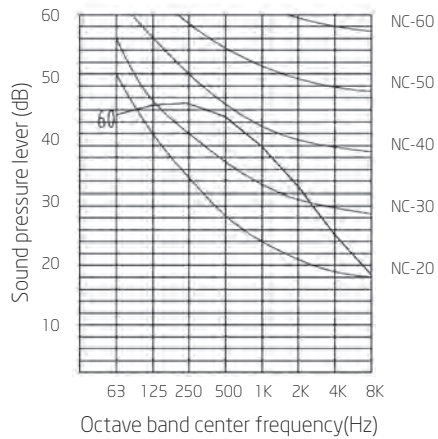

FCU-70

Standard Type

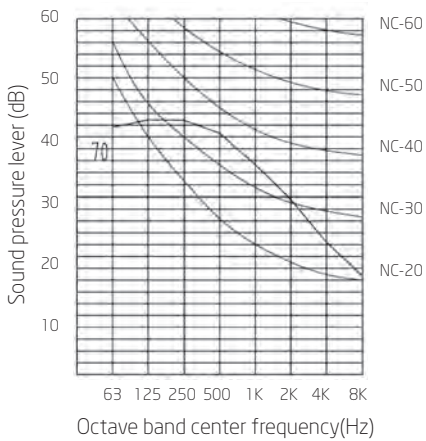

Medium Static Pressure Type

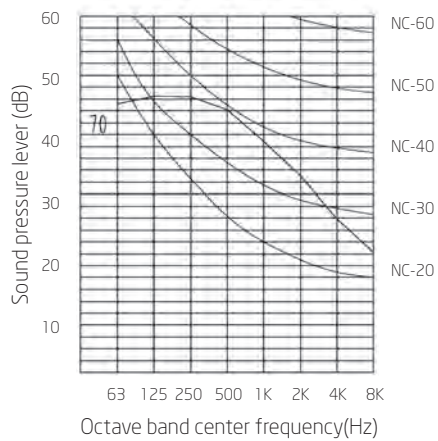

* note: The unit measure in a semi-anechoic environment, 1.0m from sound source.

Ceiling Concealed Type Noise Curves

(AW-2, AWH-2, AW-3, AWH-3) 2+1 rows and 3+1 rows

FCU-80

Standard Type

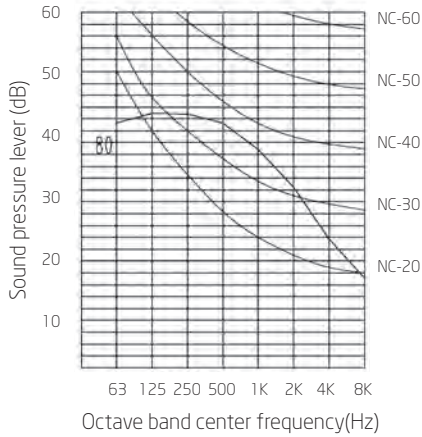

Medium Static Pressure Type

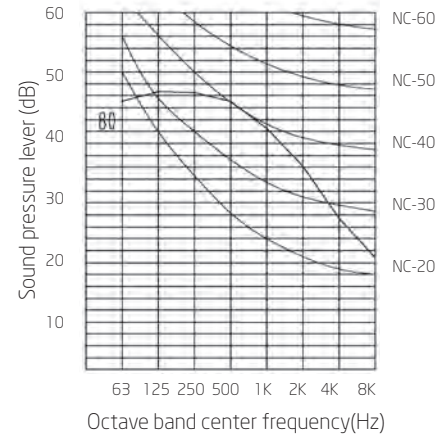

FCU-100

Standard Type

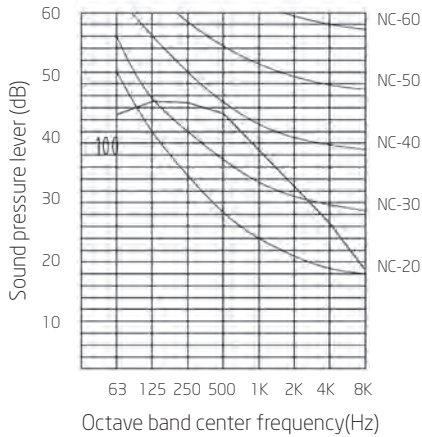

Medium Static Pressure Type

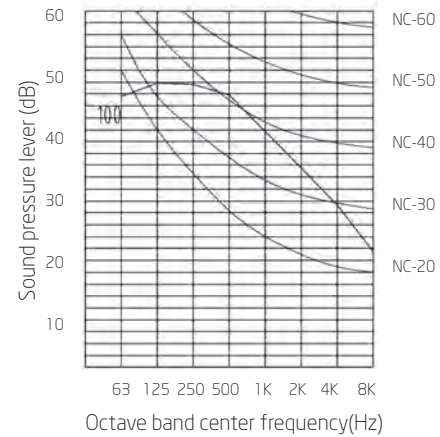

FCU-120

Standard Type

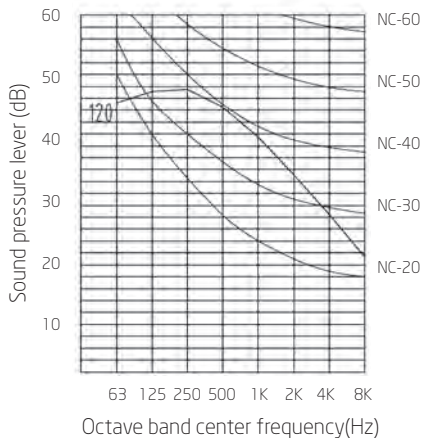

Medium Static Pressure Type

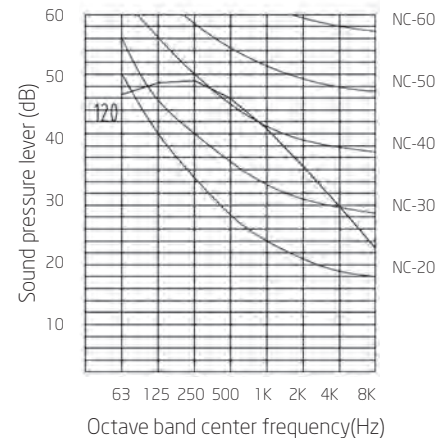

FCU-140

Standard Type

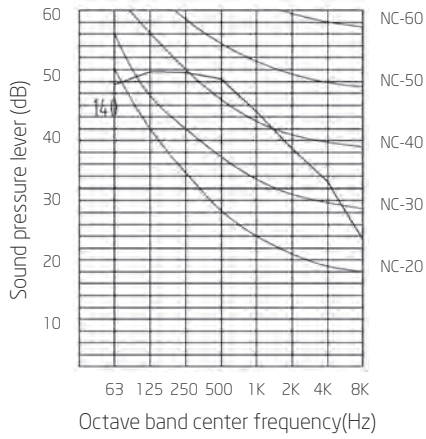

Medium Static Pressure Type

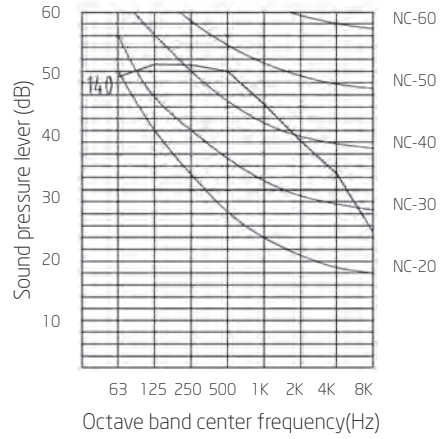

* note: The unit measure in a semi-anechoic environment, 1.0m from sound source.

Floor Concealed Type Fan Curves

(AL-2, AL-3)

FCU-20

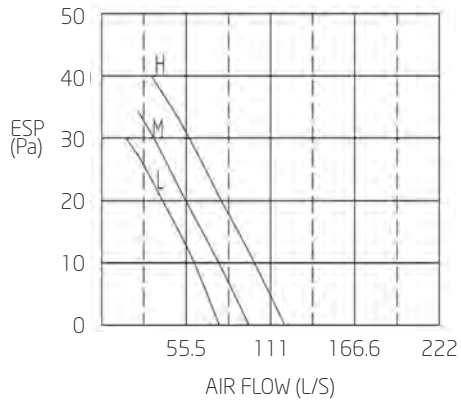

FCU-30

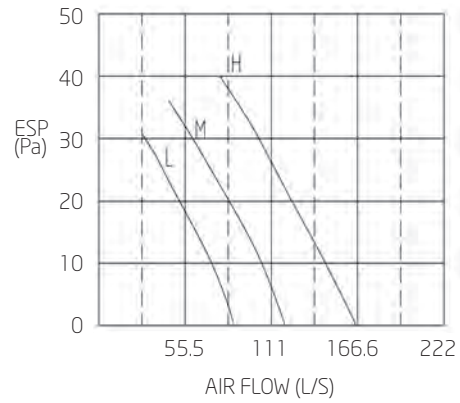

FCU-40

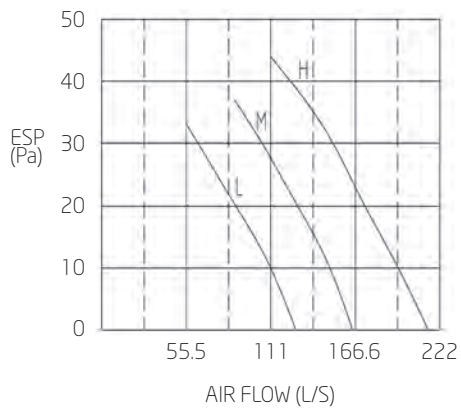

FCU-50

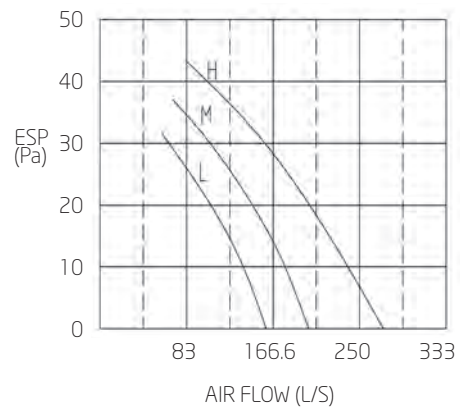

FCU-60

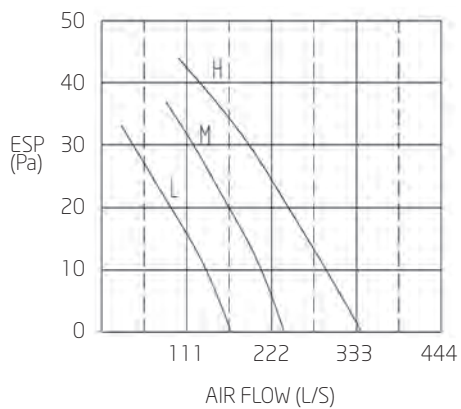

FCU-70

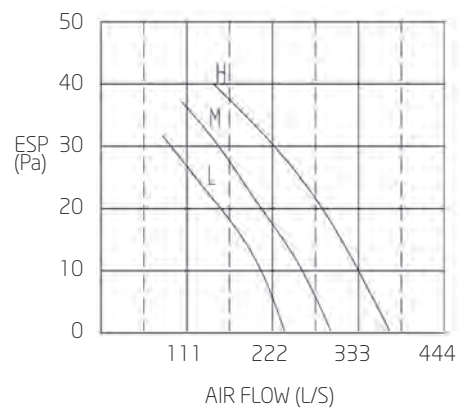

FCU-80

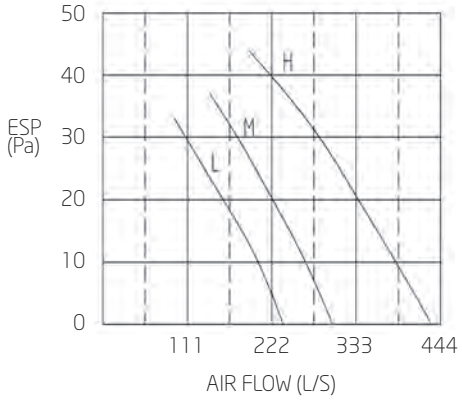

FCU-100

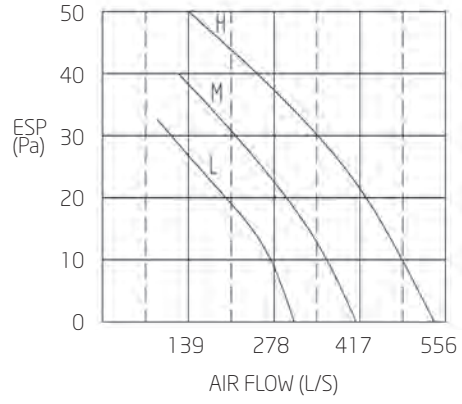

FCU-120

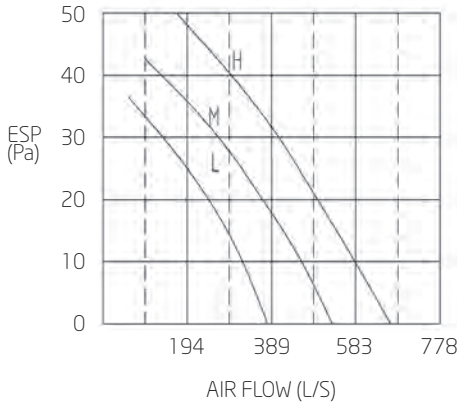

FCU-140

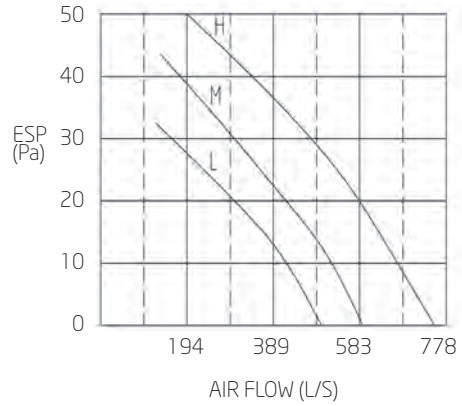

* note: The unit measure in a semi-anechoic environment, 1.0m from sound source.

Floor Concealed Type Noise Curves

(AL-2, AL-3)

FCU-20

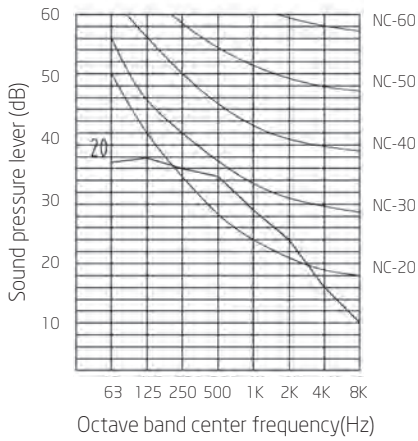

FCU-30

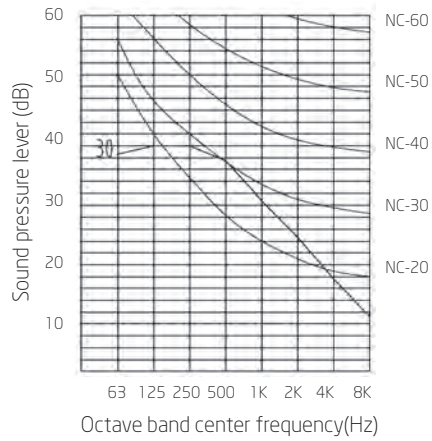

FCU-40

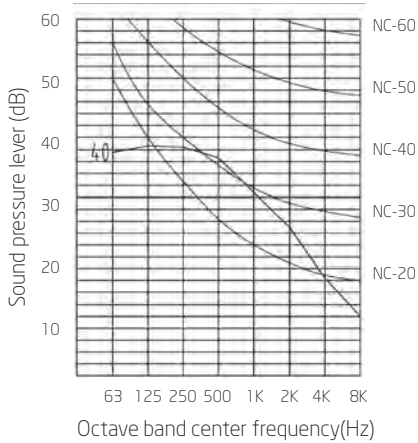

FCU-50

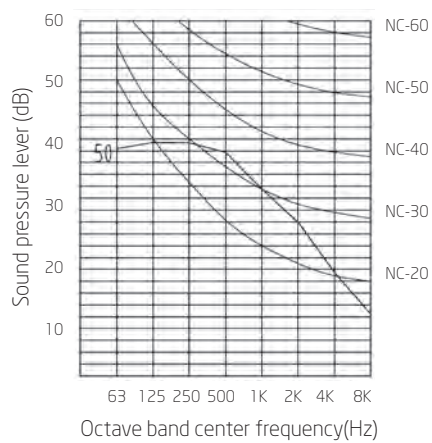

FCU-60

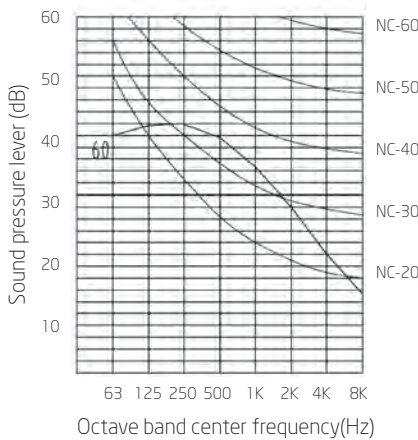

FCU-70

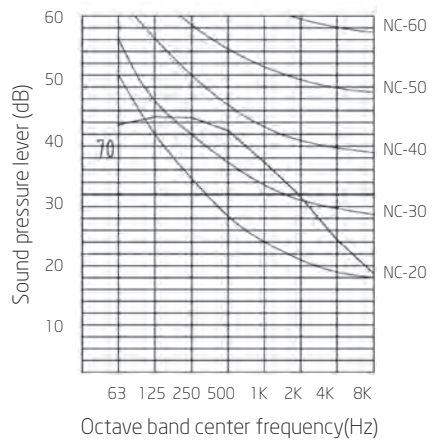

FCU-80

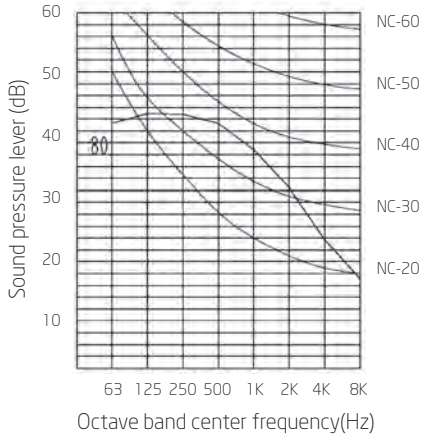

FCU-100

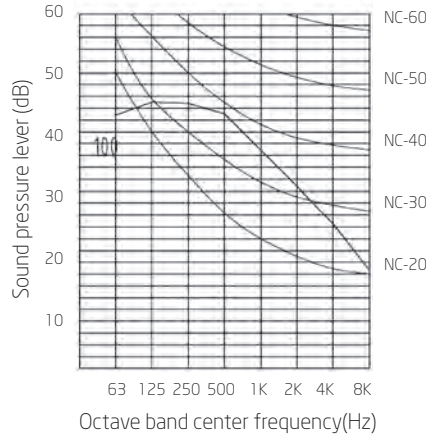

FCU-120

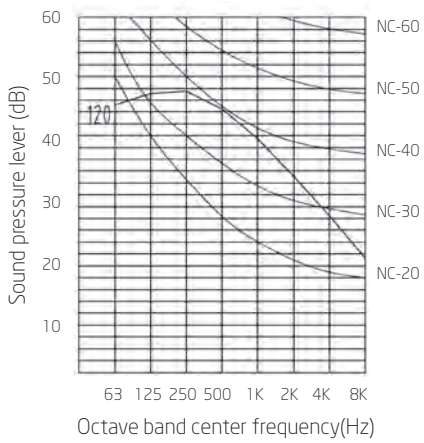

FCU-140

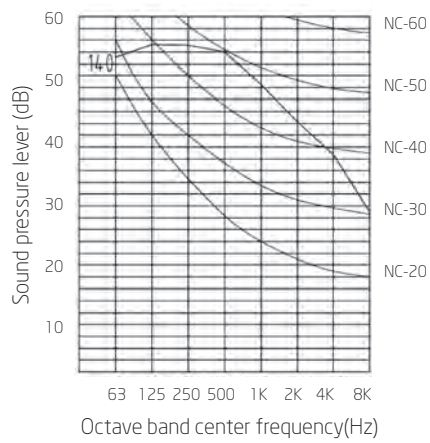

* note: The unit measure in a semi-anechoic environment, 1.0m from sound source.

Floor Exposed Type Fan Curves

(ML-2, ML-3)

FCU-20

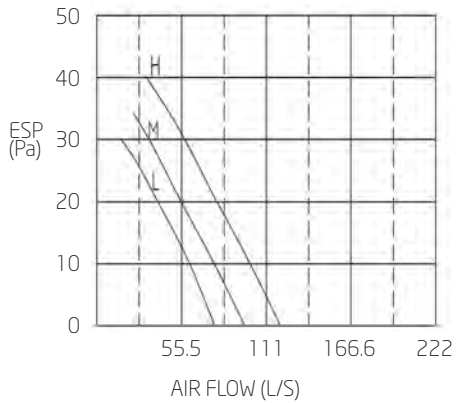

FCU-30

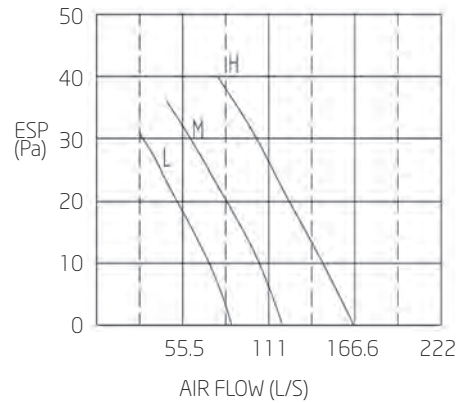

FCU-40

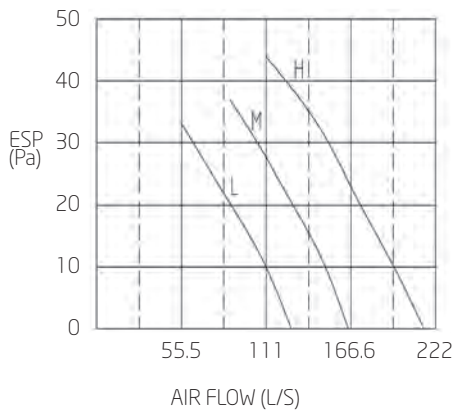

FCU-50

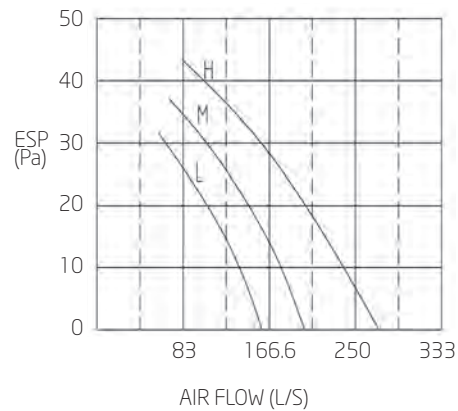

FCU-60

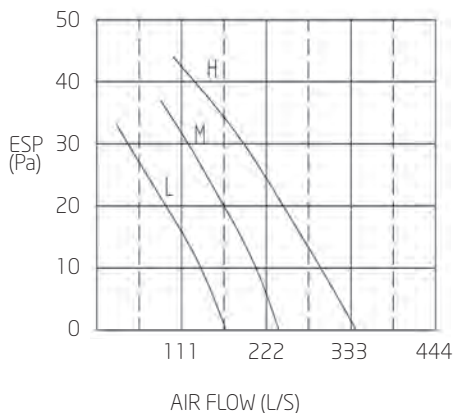

FCU-70

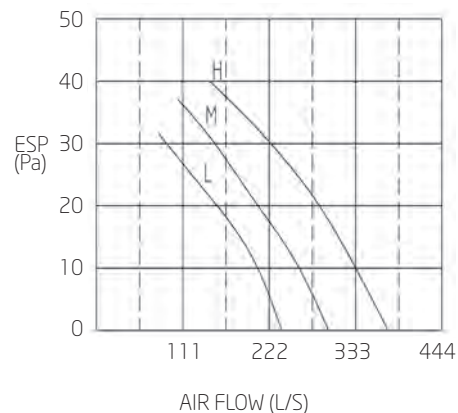

FCU-80

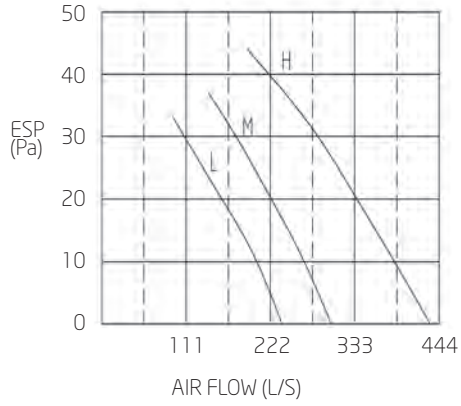

FCU-100

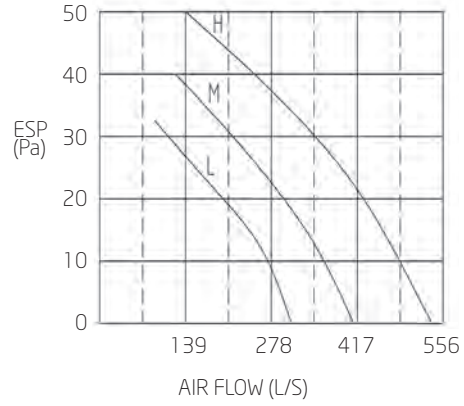

FCU-120

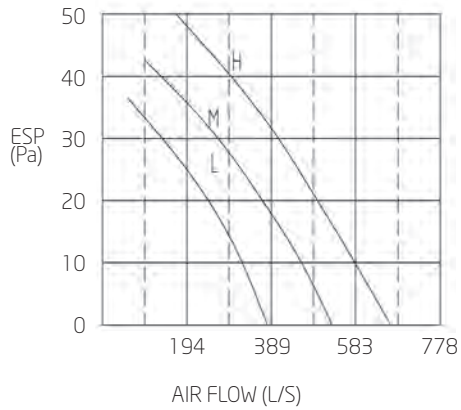

FCU-140

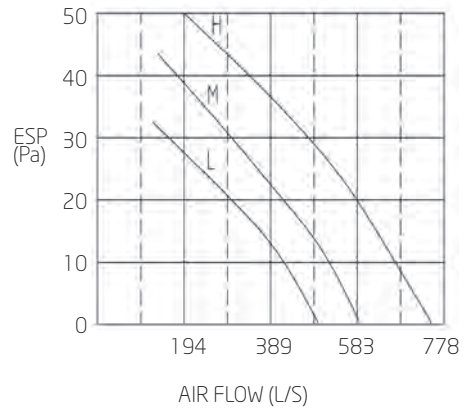

* note: The unit measure in a semi-anechoic environment, 1.0m from sound source.

Floor Exposed Type Noise Curves

(ML-2, ML-3)

FCU-20

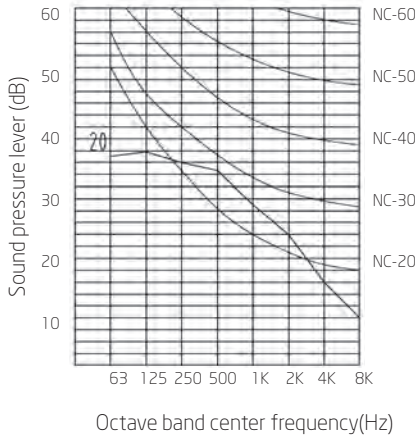

FCU-30

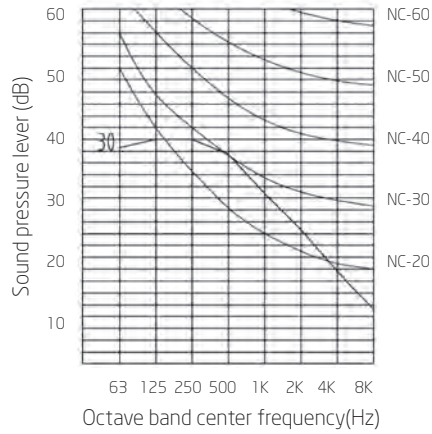

FCU-40

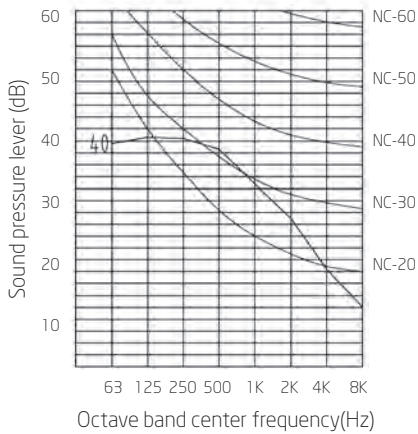

FCU-50

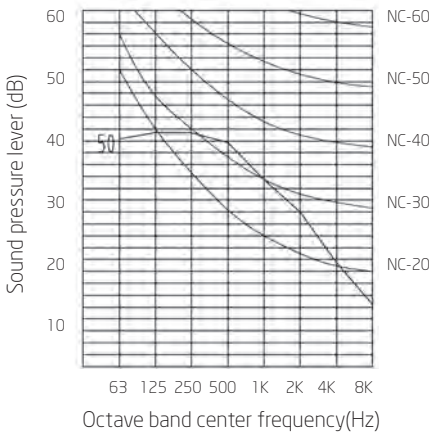

FCU-60

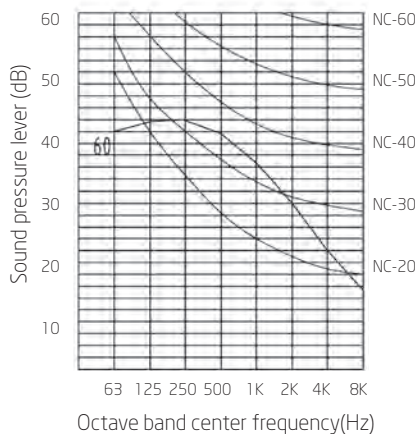

FCU-70

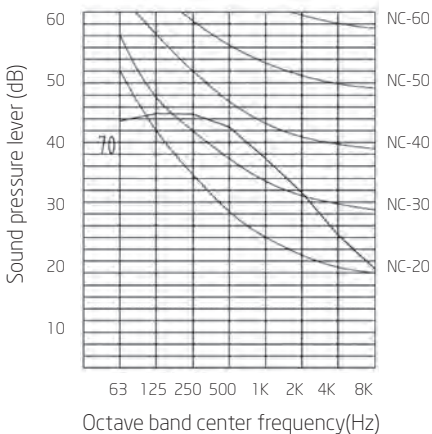

FCU-80

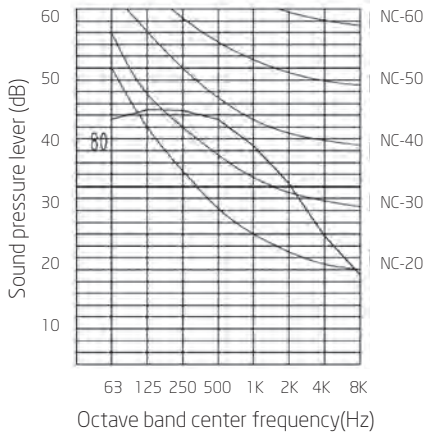

FCU-100

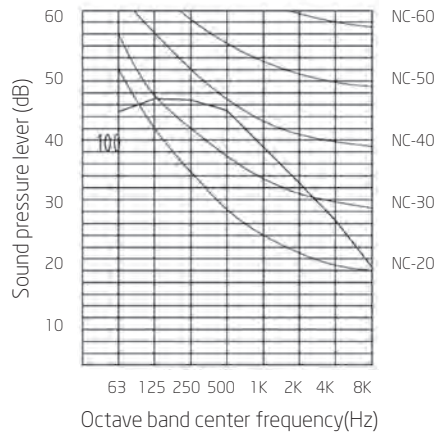

FCU-120

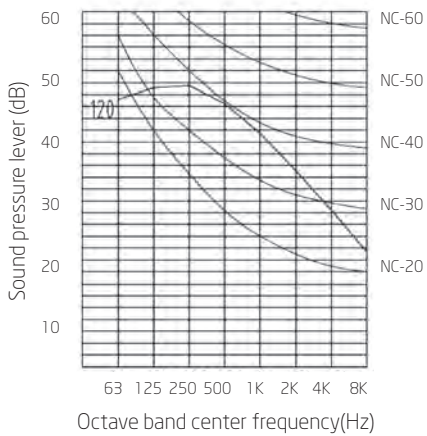

FCU-140

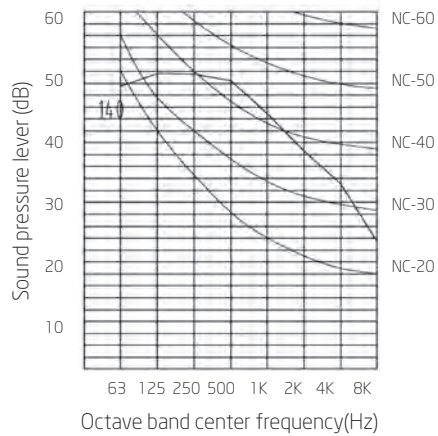

* note: The unit measure in a semi-anechoic environment, 1.0m from sound source.

Ceiling Exposed Type Fan Curves

(CE-2, CE-3)

FCU-20

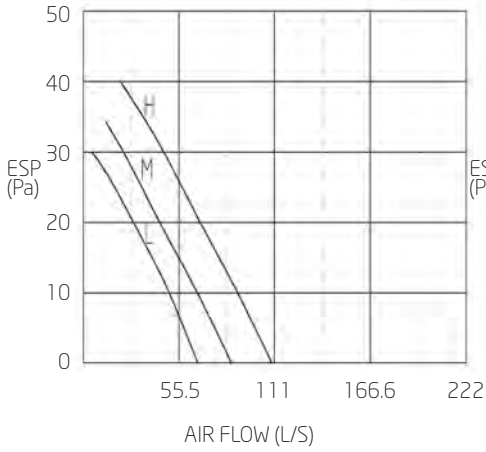

FCU-30

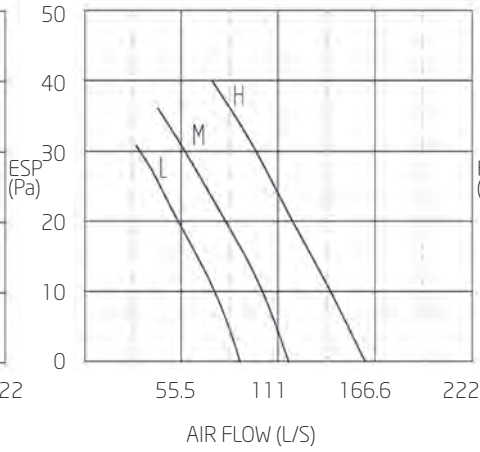

FCU-40

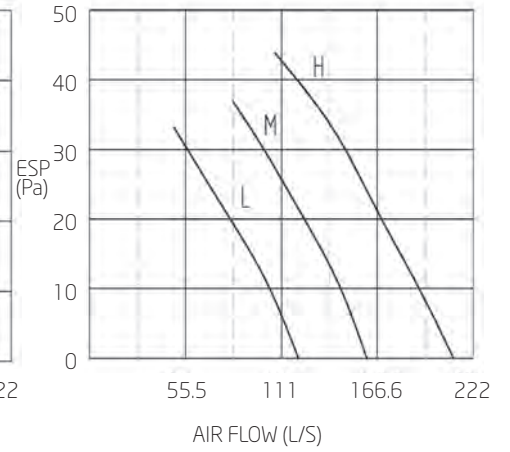

FCU-60

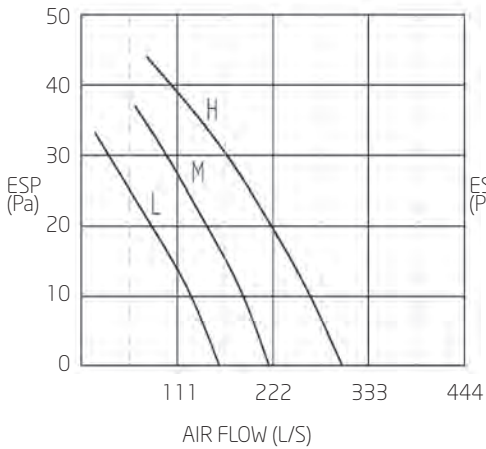

FCU-80

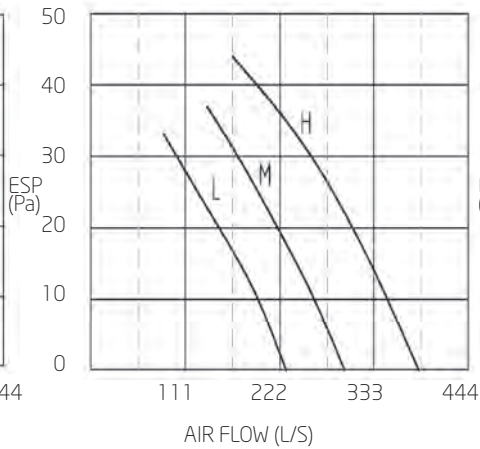

FCU-100

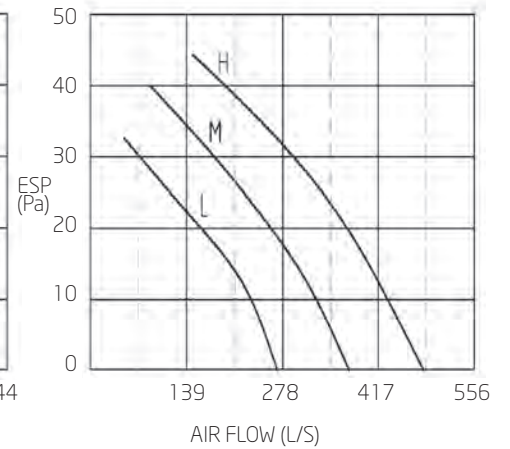

FCU-120

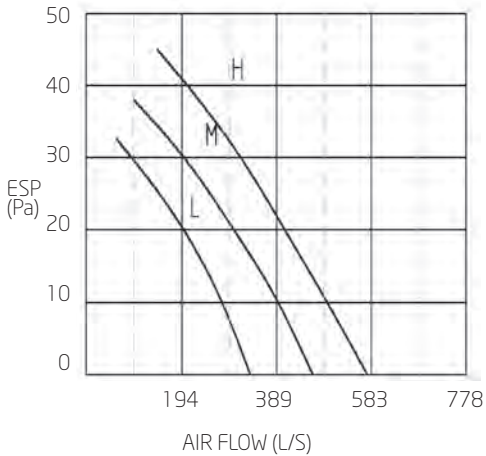

Ceiling Exposed Type Noise Curves

(CE-2, CE-3)

FCU-20

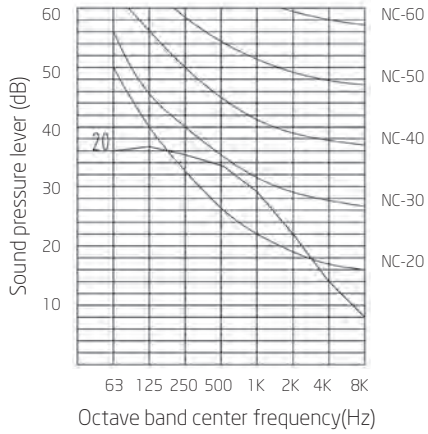

FCU-30

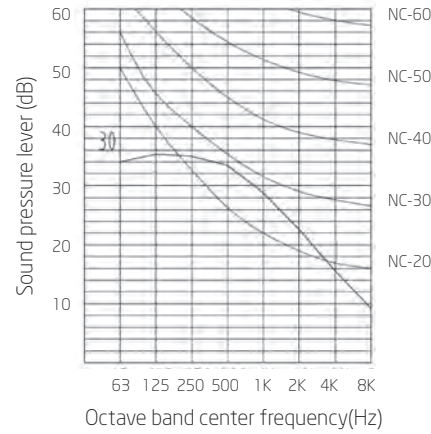

FCU-40

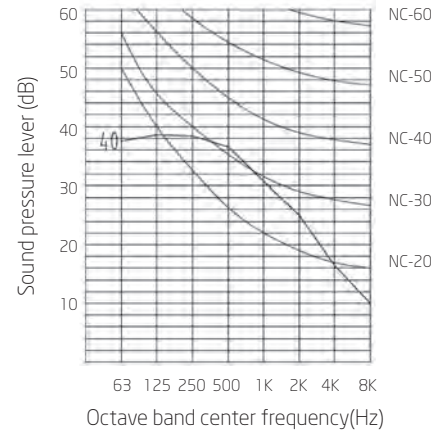

FCU-60

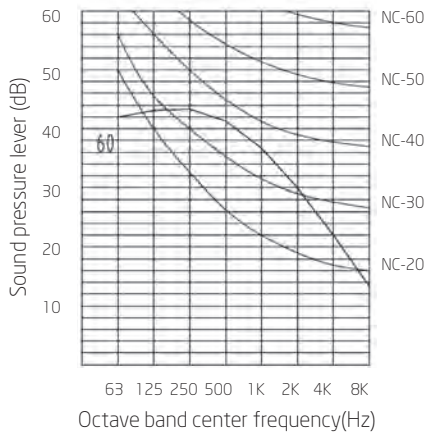

FCU-80

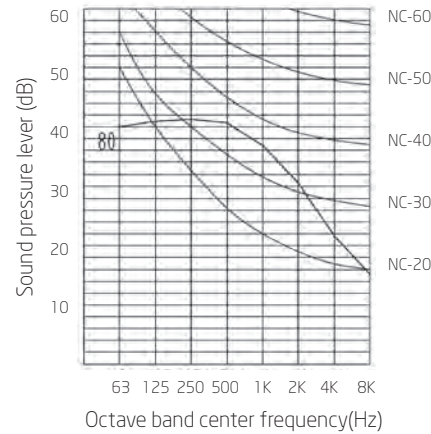

FCU-100

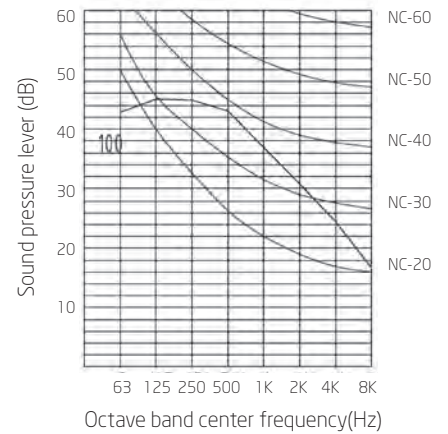

FCU-120

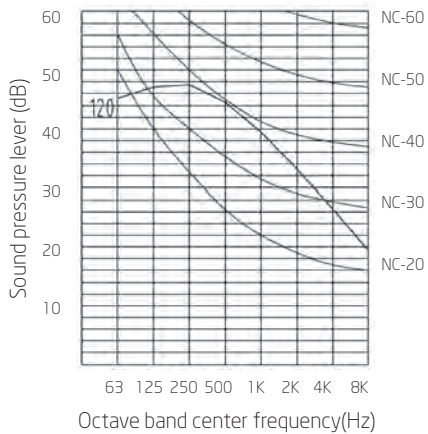

* note: The unit measure in a semi-anechoic environment, 1.0m from sound source.

Ceiling Cassette Fan Curves

(FCU XD-A)

FCU-20

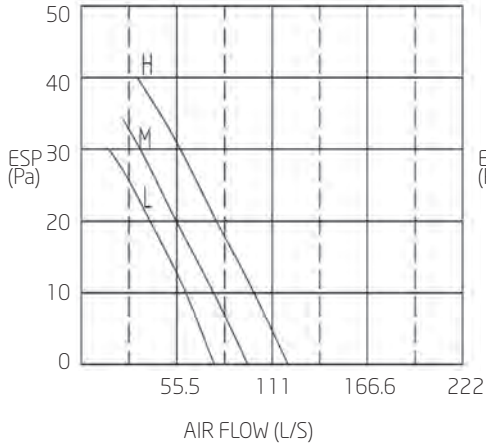

FCU-30

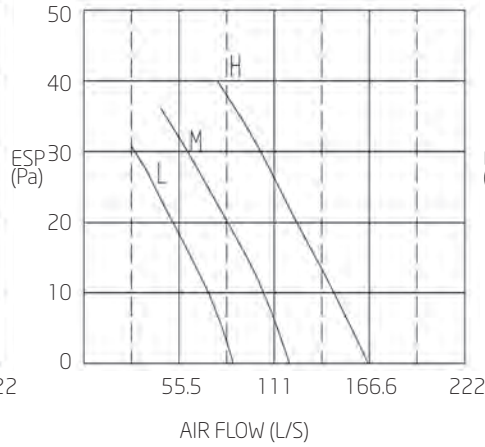

FCU-40

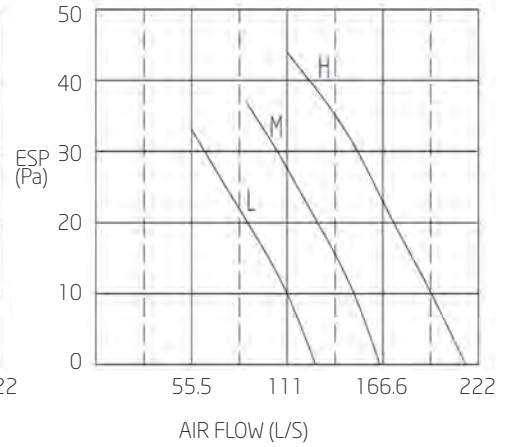

FCU-50

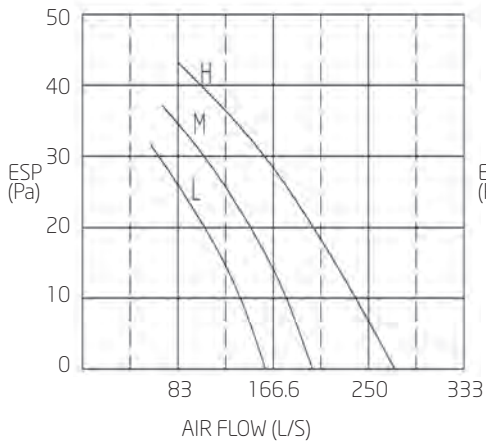

FCU-60

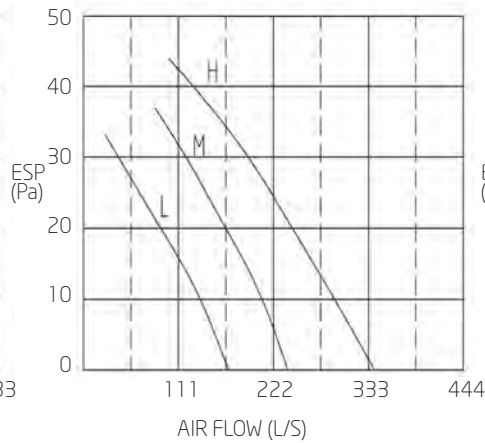

FCU-80

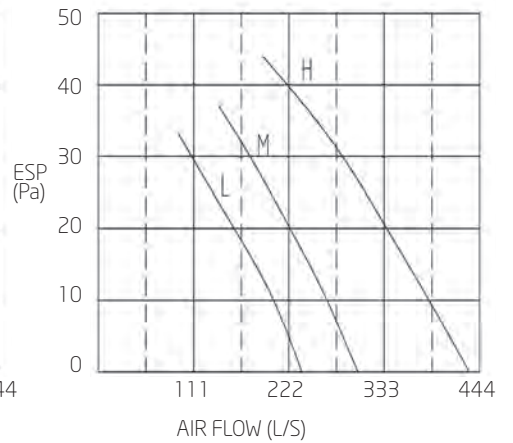

FCU-100

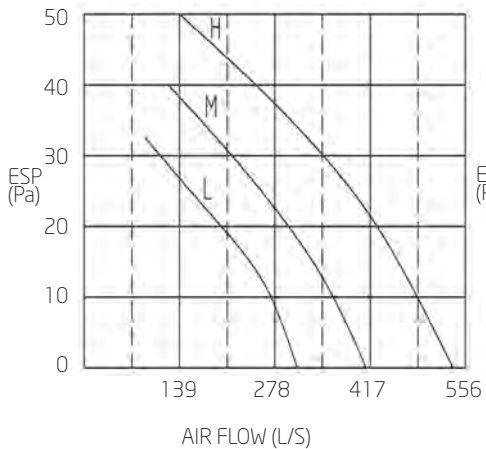

FCU-120

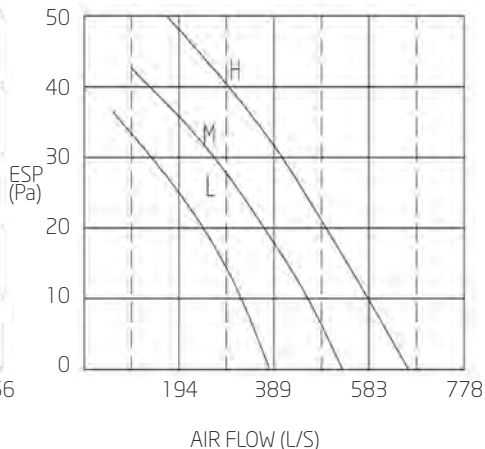

Ceiling Cassette Noise Curves

(FCU XD-A)

FCU-20

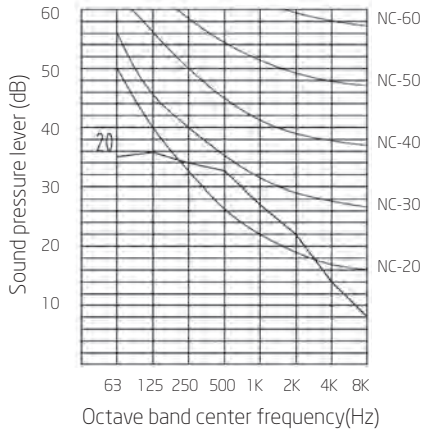

FCU-30

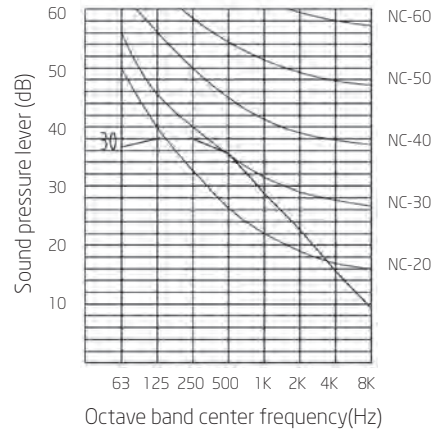

FCU-40

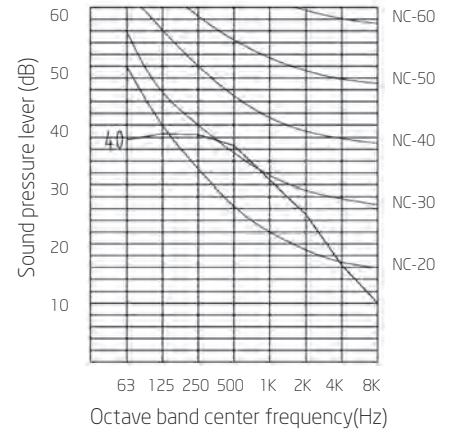

FCU-50

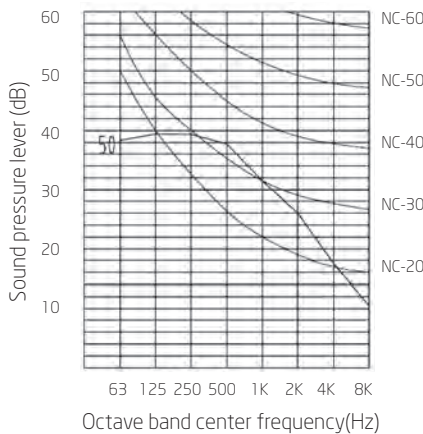

FCU-60

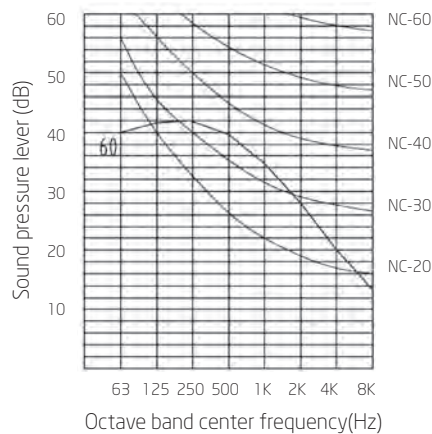

FCU-80

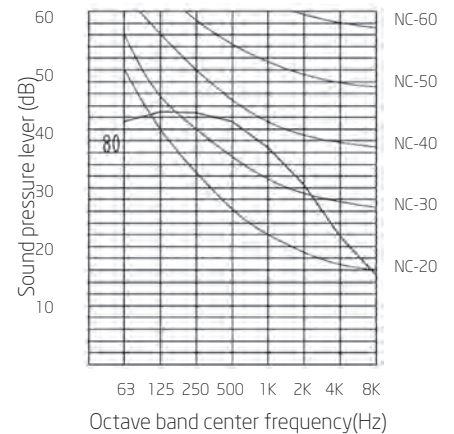

FCU-100

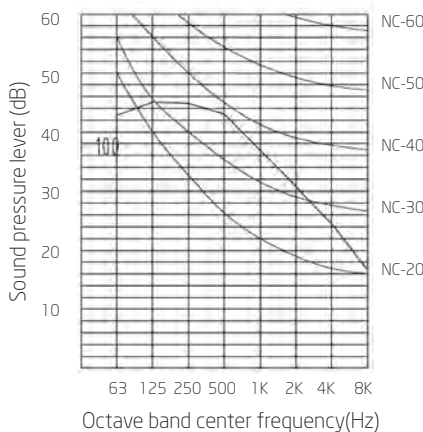

FCU-120

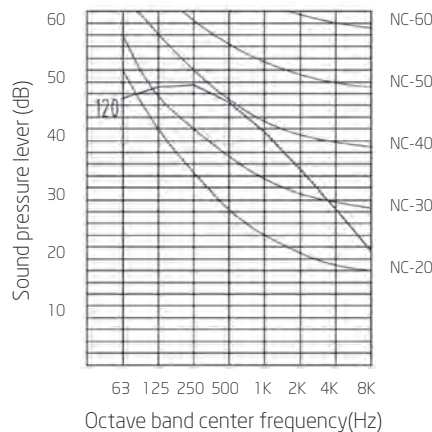

* note: The unit measure in a semi-anechoic environment, 1.0m from sound source.



DUNNAIR (Aust) Pty Ltd

Head Office: 140 Bernard Street, Cheltenham VIC 3192

P 03 8586 8200

F 03 8586 8201

E salesaust@dunnair.com.au

W www.dunnair.com.au

Dunnair New South Wales:

P 02 9674 1577

F 02 9674 1588

E salesnsw@dunnair.com.au

Dunnair Victoria:

P 03 9558 7001

F 03 9551 1644

E salesvic@dunnair.com.au

Dunnair SA & NT:

P 08 8240 2888

F 08 8240 2777

E salessa@dunnair.com.au

Dunnair Queensland:

P 07 3890 8796

F 07 3890 8642

E salesqld@dunnair.com.au

Dunnair Western Australia:

P 08 9418 2444

F 08 9418 2100

E saleswa@dunnair.com.au

Dunnair Tasmania:

P 0418 756 643

F 03 6425 3531

E salestas@dunnair.com.au

New Zealand (agent):

P +64 9 582 1012

E salesnz@dunnair.com.au

DUNNAIR OVERSEAS REPRESENTING OFFICES

New Zealand (agent):

P: +64 9 582 1012

E: salesnz@dunnair.com.au

Contact: Mr Rob Morgan

Shanghai:

P: +86 158 8806 3726

E: salesshh-china@dunnair.com.au

Contact: Ms Shelly Xiong

Hong Kong:

P: +852 2575 7080

E: saleshk@dunnair.com.au

Contact: Ms Fanny Leung

Thailand:

P: +66 8 7074 2965

E: salesth@dunnair.com.au

Contact: Mr Giuseppe Di Martino

Guangzhou:

P: +86 139 0238 2104

E: salesgz-china@dunnair.com.au

Contact: Mr Jeff He

Singapore:

Add: 240 Macpherson Road, #05-04/05,

Pines Industrial Building Singapore 348574

E: salessg@dunnair.com.au

Contact: Mr Derek Wong

*Dunnair (Aust) Pty Ltd supports a policy of continuous product improvement.
Therefore specification and designs are subject to change without prior notice.
Dunnair (Aust) Pty Ltd accepts no responsibility for possible errors in catalogues,
brochures and other printed material.*

www.dunnair.com.au